

Rohr- Montage- Systeme



MEFA

■ Bitte beachten!

- Diese Preisliste ist gültig ab 01.01.2006.
Die angegebenen Preise sind Preise ohne MwSt.
- Frühere Preislisten werden hiermit ungültig.
- Legierungszuschläge für Produkte aus Edelstahl werden zum jeweils am Tage der Auftragserteilung gültigen Satz berechnet.

Die aktuellen Legierungszuschläge finden Sie auf unserer Website www.mefa.de !

- Technische, Sortiments- und Preisänderungen vorbehalten.
- Haftung für Druckfehler und -mängel wird ausgeschlossen.

■ MEFA Befestigungs- und Montagesysteme GmbH

Schillerstraße 15 Tel.: +49 (0) 7944-64-0
D-74635 Kupferzell Fax: +49 (0) 7944-64-37

Postfach 51 Email: info@mefa.de
D-74633 Kupferzell URL: www.mefa.de

MEFA-Deutschland

Zentrallager/ Versand/ Fertigung

Am Wasserturm 7 - 9
D-74635 Kupferzell

Service Zentrum Berlin

Mirastraße 54
D-13509 Berlin (Reinickendorf)
Tel.: 030-60 67 091
Fax: 030-60 67 065

Service Zentrum München

Hausen 12
D-85551 Kirchheim
Tel.: 089-90 39 066
Fax: 089-90 31 266

Service Zentrum Nürnberg

Dr.-Wild-Straße 9
D-90766 Fürth
Tel.: 0911-73 64 77
Fax: 0911-75 93 195

MEFA-Auslandsniederlassungen

Italien:

MEFA Italia S.r.l.
Via G. B. Morgagni 16/B
I - 20010 Pogliano Milanese (MI)
Tel.: +39-02-935 401 95
Fax: +39-02-935 426 90
Email: info@mefaitalia.com
URL: www.mefaitalia.com

Polen:

MEFA-Polska Sp. z o. o.
ul. Sloneczna 52 G
PL - 05-500 Stara Iwiczna
Tel.: +48-22-737 209 0
Fax: +48-22-737 208 9
Email: poczta@mefa-polska.com.pl
URL: www.mefa-polska.com.pl

Ungarn:

MEFA-Promt Hungaria Kft
Szentlászlói u. 160
H - 2000 Szentendre
Tel.: +36-26-300 499
Fax: +36-20-311 634
Email: info@mefapromt.hu
URL: www.mefapromt.hu

Dänemark:

MEFA Nordic AS
Lucernevej 67
DK - 8900 Randers tlf
Tel.: +45-879-150 00
Fax: +45-879-150 01
Email: info@mefanordic.dk
URL: www.mefanordic.dk

Inhalt

Artikel	Katalog Kapitel/Seite	Preisliste Seite
A		
Abhänger	02/26	21
Abstandswinkel	05/07	32-33
Ansatzschrauben	05/13	37
Anschlußadapter	01/28	11
B		
Beschilderungen	11/01	59
Blechzylinder	06/14	43
Bohrer	10/03	59
Bohrkonsolen	07/24	49
Bohrschraube	08/12	53
C		
Clipmaster	01/28	11
D		
Dämmauflage LK,	08/11	53
Dämmelement DHL	08/07	52
Deckenhänger TF	04/03	29
Distanzmuffen	05/09	33
Distanzrohr	05/10	34
Doppelhalter	05/02-03	31
Doppelnippel	05/10	34
Dübel		
• AB Schwerlast-Anker	07/12	46
• EA Einschlaganker	07/11	46
• FAZ + FAZ II Ankerbolzen verzinkt	07/08	45
• FIS-V Injektions-Mörtel	07/18	47
• FZA und FZA-I Zykon-Anker	07/13-14	46
• FZEA Zykon-Einschlaganker	07/09-10	45-46
• FHB Highbond-Anker	07/16	47
• FHY Hohldeckenanker	07/20	48
• GB Gasbetondübel	07/04	44
• K2-Kunststoffdübel	07/02	44
• Klappdübel SK	07/21	48
• Kippdübel	07/21	48
• LB-Dübel	07/03	44
• Messing-Spreizdübel	07/02	44
• R Reaktionsanker	07/15	47
• UUE-Dübel	07/03	44
• TSM-Betonschraube	07/05-06	44-45
E		
Ecklasche 4-Loch	02/23	19
Eckverbinder 4-Loch	02/24	20
Eckwinkel	02/24	19
Edelstahl		
Distanzmuffen	13/17	70
Doppelnippel	13/19	72
Ecklasche	13/10	65
Edelstahlrohrschellen		
• mit Schalldämmprofil	13/01-02	61
• ohne Schalldämmprofil	13/03-04	62
• für Lüftungsrohre	13/05	63
Fertigkonsole	13/14	68
Festpunkt Typ A	13/20	73
Gelenkhalter für Profilschienen	13/12	67
Gelenkhalter mit Anschlußlochung	13/13	67
Gewindeplatten 2-Loch	13/09	64
Edelstahl		
Gewindeplatten 4-Kant	13/09	64
Gewindestangen	13/18	70

Artikel	Katalog Kapitel/Seite	Preisliste Seite
Gewindestifte	13/18	71
Gleiter GL 100	13/16	69
Gleitplatten	13/16	69
Grundplatten	13/17	70
Hängebügel Typ L	13/15	69
Halter mit Grundplatte	13/12	66
Halter für Doppel-C-Profil	13/12	66
Kanalhalter	13/06	63
Knotendreieck	13/11	66
Knotenkonsole L	13/13	67
Kreuzlasche	13/10	65
Lochplatte	13/09	64
Lochwinkel	13/11	65-66
Muttern	13/19	71
Profilhalter	13/09	65
Profilschienen	13/07	64
Rundstahlbügel	13/06	63
Schienengleiter 45K	13/17	69
Schrauben	13/18	71
Spannklaunen	13/15	68
Stirnplatte	13/13	67
Strebe 45	13/14	68
Stockschrauben	13/19	72
T-Lasche	13/10	65
Trapezblechhänger	13/15	68
Trägerklammer	13/14	68
U-Scheiben	13/19	72
Wandausleger	13/14	67
Winkelkonsole	13/13	67
Z-Niederhalter	13/16	69
Zylinderschraube DIN 912	13/18	71
F		
Fallrohrstützenbefestigung SML-Rohr	3b/03	27
Federhänger	3c/04	27
Federtöpfe	3c/04	28
Fertigkonsolen 36/40	02/31	22
Fertigkonsolen 45/40,52,60,80	02/32-33	22-23
Festpunkte		
• Typ A	3a/02	24-25
• Typ A mit Gelenkhalter	3a/04	25
• Typ AK	3a/06	25-26
• Typ B	3a/02	24-25
• Typ FGL + FGL Rohrschelle	3a/07	26
Festpunktconsole	03a/8	26
Flachverbinder 35/4 3-Loch	02/08	14
Flachverbinder 40/6 3-Loch	02/20	18
Flachverbinder 35/4 4-Loch	02/08	14
Flachverbinder 40/6 4-Loch	02/20	18
Flachverbinder 35/4 L-Form	02/10	15
Flachverbinder 40/6 L-Form	02/20	18
Flachverbinder 35/4 T-Form	02/10	15
Flachverbinder 40/6 T-Form	02/20	18
G		
Gelenkhalter	02/29	21-22
Gewindehaken	05/06	32
Gewindegewindestift	05/07	32
Gewindeplatten Typ 35	02/06	13
Gewindeplatten Typ 45	02/18	17
Gewindeplatten 4-Kt. Typ 35	02/07	14

Inhalt

Artikel	Katalog Kapitel/Seite	Preisliste Seite
Gewindeplatten 4-Kt. Typ 45	02/19	18
Gewindeplatten 35/4 2-Loch	02/08	14
Gewindeplatten 2-Loch Typ 45	02/19	18
Gewindestangen	05/08	33
Gewindestifte	05/08	33
Gleitelement -radial-axial	04/02	29
Gleitelement -radial-axial GL 37	04/04	29
Gleitelement -radial-axial GL 100 und GL 200	04/06	30
Gleiter -GL 37	04/04	29
Gleiter -GL 100 und GL 200	04/05	29-30
Gleitplatten	04/01	28
Gleitstreifen	04/02	28
Grundplatten	05/01	30-31
H		
Halter 38/51/150 (HOLORIB)	02/28	21
Halter für Doppel-C-Profile 45	02/27	21
Halter 35	02/07	14
Halter für C-Profile	02/27	21
Hammerkopfschrauben Typ 35	02/06	13
Hammerkopfschrauben Typ 45	02/18	17
Hängebügel L	04/03	29
Hängebügel T	05/03	31
Heizkörperbefestigungen	07/24	49
Höhenregulierstück	05/04	32
Höhenversteller	05/03	31
Husky-Kälteschelle	06/07	38
Hutprofil	02/26	21
I		
Isolierung Kautschuk		
• Isolierplatte K	09/09	56
• Isolierschlauch Kautschuk W	09/07	56
• Isolierschlauch Kautschuk K	09/08	56
• Klebebänder und Spezialkleber	09/10	56-57
Isolierung PE		
• für Abflußrohre	09/03	55
• Polycell 2000	09/01	54
• Steinoflex-Isolierschlauch	09/03	55
• Steinoflex-Dämmblock	09/05	55
• Steinoflex-Ultra	09/04	53
• Steinojet	09/02	54
• Isolierbänder	09/06	55
Isolierschlauch Polyester	09/11	57
Isolierstreifen Polyester	09/12	57
K		
Kälteschelle Alu/PU 80	06/12-13	39-40
Kälteschelle Alu/PU 80 s	06/14-15	41-42
Kaltschrumpfband	08/13	53
Kanalabhängungen	08/09	-
Kanaldichtband	08/13	53
Kanaldichtpaste	08/13	53
Kanalhalter SD	08/08	52
Kanalklammer	08/12	53
Kanalschienen Gummi KG	08/11	53
Keilmutter für Verbunddecken	02/36	24
Knotendreieck 40/5	02/21	18
Knotenkonsole L	02/30	22
Kombi-Profilhalter	02/-	20
Kreuzlasche	02/23	19

Artikel	Katalog Kapitel/Seite	Preisliste Seite
L		
Langlochschrauben	05/14	36
Laschengarnituren	07/22	49
Laschenschrauben	05/14	35
Locher Paste 2000	10/01	58
Locher Paste Solar	10/02	58
Lochplatte 45/40, 60	02/19	18
Lochplatte 2-Loch 35/4	02/08	14
Lochzange für Trapezbleche	05/06	32
Lüftungsrohrschellen		
• Doppio	08/01	50
• mit Schalldämmung	08/02-03	50
• ohne Schalldämmung	08/04-05	51
• mit DHL	08/06	52
M		
Messing-Holzschrauben	05/15	36
Montagebänder	05/16	36
Montagegarnituren	07/23	49
O		
Ösensschrauben	05/14	36
P		
Pendelaufhänger	05/04	32
Pendelgelenk	05/04	32
Polar-Kälteschelle	06/05	37-38
Profilhalter Typ 35	02/07	14
Profilhalter Typ 45	02/26	20-21
Profilschienen 35	02/05	13
Profilschienen 45	02/14-15	15-16
PU-Montagekleber	06/16	44
R		
Reduziermuffen	05/09	34
Reduzierstücke	05/09	34
Rohrclip-Clipmaster	01/28	10
Rohrklemmen		
• Duplo D	01/23	10
• Duplo L	01/24	10
• Duplo Doppel	01/25	10
• Duplo Zubehör	01/26	11
Rohrschellen		
• Clipstar	01/22	10
• Omnia einteilig	01/04	1-2
• Omnia-Gleitrohrschelle zweiteilig	01/09	3
• Omnia MB zweiteilig	01/06-07	2-3
• Sicht-Rohrschelle	01/27	11
• Sigma	01/03	1
• Sigma-Gleitrohrschelle einteilig	01/08	3
• Schwerlast mit Schalldämmeinlage	01/14-17	6-8
• Schwerlast ohne Schalldämm.	01/18-20	8-9
• Standard PSM mit Schalldäm.	01/10-11	4-5
• Standard PSM ohne Schalldäm.	01/12-13	5
• Trabant	01/05	2
Rollenlager	04/07	30
Rundstahlbügel	01/21	9
S		
Schalldämmeinlage	01/02	1
Schallentkopplungs-Set f. Klemmfestp.	03a/9	27
Schiebestück	04/03	29
Schienenleiter 45 K	04/07	30
Schienenklammer	02/35	24

■ Inhalt

Artikel	Katalog Kapitel/Seite	Preisliste Seite
Schlagstifte	05/13	36
Schraubbolzen	05/02	31
Schutzkappen Typ 35	02/06	14
Schutzkappen Typ 45	02/18	17
Sechskantmuttern	05/12	35
Sechskantschrauben	05/11	34-35
Sicherungsglasche	05/17	37
Spannklauen	02/34	23
Spannkrallen	02/34	23
Spannbügel-SET	02/35	24
Spezialkleber, siliconfrei für Isolierung	09/10	57
Spiralrohr-Abhänger	08/07	52
Sprinkler		
• Rohrschlaufe	12/07	60
• Rohrschelle Typ SP	12/08	60
• Rohrschlaufe R	12/09	60
Steckverbinder SIMA >S<	3b/01	27
Stex 35	02/02	12
Stex-Gewindebolzen 35 GB	02/02	12
Stex-Halter 35/35	02/03	12
Stex-Konsolen 35	02/04	12
Stex-Montageschiene	02/01	12
Stex-Schienengummi	02/04	12
Stex-Schutzkappen	02/04	12
Stex-Universalwinkel 35	02/03	12
Stex-Winkel 35	02/03	12
Stex 45 Gewindebolzen GB	02/16	16
Stex 45 Gewindeplatte GP	02/16	16
Stex 45 Montagebolzen MTB	02/17	17
Stex 45 Montageplatte MP	02/16	17
Stirnplatte 35/4	02/10	15
Stirnplatte 45/40	02/25	20
Stockschrauben	05/13	35
Strebe 45°-T-Profil	02/33	23
Stufenwinkel	02/25	20
T		
T-Lasche	02/23	19
Trägerklammer TK	05/16	37
Trägerklammer F3 + F9	05/17	37
Trägerklemmung	02/36	24
Trapezblechhänger	05/05	32
Trapezblechhänger mit Schalldämm.	08/12	53
Trennscheibe MEFAFLEX	10/04	59
U		
Überwurfmuffe	05/10	34
Übergangsverbinder SIMA-CON	3b/05	27
Universalkonsole	02/30	22
Uni-Profilhalter	02/26	21
Unterlegscheiben	05/12	35
V		
Verbinderkralle SIMA-Cramp >S<	3b/02	27
Verbindungsstück	02/25	20
Vierfachschlüssel	05/13	35
W		
Wandausleger	02/31	22
WC-Befestigungen	07/22	48
Winkelkonsole	02/30	22
Winkel 2-Loch 35/4	02/09	14
Winkel 2-Loch 40/6	02/21	18

Artikel	Katalog Kapitel/Seite	Preisliste Seite
Winkel 3-Loch 35/4	02/09	15
Winkel 3-Loch 40/5	02/21-22	18-19
Winkel 4-Loch 35/4	02/09	15
Winkel 4-Loch 40/5	02/22	18-19
Z		
Zahnbolzen	02/17	17
Zahnplatte S	02/17	17
Zahnplatte DS	02/-	17
Zinkausbesserungsspray	10/03	58
Zinkspray-Zinkgrundierung	10/02	58
Z-Niederhalter	04/02	28
Zylinderschrauben	05/10-11	34



■ C-Schalldämmeinlage schwarz (EPDM/SBR)

Schematische Darstellung

Abmessung [mm]	Artikel-Nr.	VPE [m]	PE [m]	Euro/PE
20x4,5	7201214	30	1	1,80
25x4,5	7201257	30	1	2,05
20x6,0	7200218	20	1	2,90
25x6,0	7200250	20	1	3,25
30x6,0	7200307	25	1	4,25
35x6,0	7200358	25	1	4,75
50x6,0	7201508	25	1	8,50



■ C-Schalldämmeinlage rot (Silicon)

Abmessung [mm]	Artikel-Nr.	VPE [m]	PE [m]	Euro/PE
20x6,0	7241208	25	1	11,55
25x6,0	7241259	25	1	13,65
30x6,0	7241305	25	1	15,50
35x6,0	7241356	25	1	16,90
50x6,0	7241518	25	1	27,90



■ Sigma-Rohrschelle mit Schalldämmeinlage

Abmessung [mm]	Artikel-Nr.	VPE [St]	PE [St]	Euro/PE
Anschlußgewinde M8 Schalldämmeinlage schwarz				
12-15	1/4"	14510151	100	71,00
16-19	3/8"	14510191	100	72,00
20-23	1/2"	14510231	100	74,00
25-29	3/4"	14510291	100	77,00
32-35	1"	14510351	100	86,00
40-44	1 1/4"	14510441	50	91,00
48-52	1 1/2"	14510521	50	96,00
53-57		14510571	50	109,00
58-60	2"	14510601	50	112,00

Anschlußgewinde M8 Schalldämmeinlage weiß				
12-15	1/4"	14590151	100	75,00
16-19	3/8"	14590191	100	77,00
20-23	1/2"	14590231	100	80,00
25-29	3/4"	14590291	100	88,00
32-35	1"	14590351	100	103,00



■ Omnia-Rohrschelle mit Schalldämmeinlage EPDM

Abmessung [mm]	Artikel-Nr.	VPE [St]	PE [St]	Euro/PE
Anschlußgewinde M8				
15		0380156	100	81,00
18	3/8"	0380180	100	81,00
22	1/2"	0380229	100	84,00
28	3/4"	0380288	100	89,00
35	1"	0380350	100	95,00
42	1 1/4"	0380423	50	102,00
44		0380431	50	104,00
48	1 1/2"	0380482	50	109,00
50		0380512	50	120,00
54		0380547	50	122,00
57		0380571	50	125,00
60	2"	0380601	50	130,00

Anschlußgewinde M10				
15		0381152	100	90,00
18	3/8"	0381187	100	90,00
22	1/2"	0381225	100	93,00
28	3/4"	0381284	100	98,00
35	1"	0381357	100	104,00
42	1 1/4"	0381411	50	111,00
44		0381446	50	113,00
48	1 1/2"	0381489	50	118,00
50		0381519	50	129,00
54		0381543	50	131,00
57		0381578	50	134,00
60	2"	0381608	50	139,00



■ **Omnia-Rohrschelle mit Schalldämmeinlage SILICON**

Abmessung [mm]	Artikel-Nr.	VPE [St]	PE [St]	Euro/PE
Anschlußgewinde M8				
15	0380652	100	100	148,00
18	3/8" 0380687	100	100	148,00
22	1/2" 0380725	100	100	164,00
28	3/4" 0380784	100	100	186,00
35	1" 0380822	100	100	211,00
42	1 1/4" 0380911	50	100	242,00
44	0380946	50	100	251,00
48	1 1/2" 0380989	50	100	267,00
50	0381012	50	100	286,00
54	0381047	50	100	295,00
57	0381071	50	100	312,00
60	2" 0381098	50	100	330,00

Anschlußgewinde M10

15	0381659	100	100	157,00
18	3/8" 0381683	100	100	157,00
22	1/2" 0381721	100	100	173,00
28	3/4" 0381780	100	100	195,00
35	1" 0381829	100	100	220,00
42	1 1/4" 0381926	50	100	251,00
44	0381942	50	100	260,00
48	1 1/2" 0381985	50	100	276,00
50	0382019	50	100	295,00
54	0382043	50	100	304,00
57	0382078	50	100	321,00
60	2" 0382094	50	100	339,00



■ **Trabant-Rohrschelle mit Schalldämmeinlage EPDM**

Abmessung [mm]	Artikel-Nr.	VPE [St]	PE [St]	Euro/PE
Anschluß: Stufengewinde M8/10				
12-15	0426151	100	100	95,00
15-20	3/8" 0426201	100	100	96,00
20-25	1/2" 0426251	100	100	106,00
25-30	3/4" 0426301	100	100	109,00
32-37	1" 0426371	100	100	119,00
42-46	1 1/4" 0426461	50	100	120,00
47-52	1 1/2" 0426521	50	100	128,00
53-58	0426581	50	100	146,00
59-65	2" 0426651	50	100	150,00
70-73	0426721	50	100	182,00

Abmessung [mm]		Artikel-Nr.	VPE [St]	PE [St]	Euro/PE
75-78	2 1/2"	0426771	50	100	188,00
85-90	3"	0426901	50	100	215,00
108-114	4"	0427141	50	100	245,00



■ **Omnia-Rohrschelle MB mit Schalldämmeinlage EPDM**

Abmessung [mm]	Artikel-Nr.	VPE [St]	PE [St]	Euro/PE	
Anschluß: Stufengewinde M8/10 SW 13					
15-20	3/8"	0398020	100	100	131,00
22-28	1/2-3/4"	0398028	100	100	134,00
30-35	1"	0398035	100	100	148,00
38-42	1 1/4"	0398042	50	100	156,00
44-48	1 1/2"	0398048	50	100	156,00
50-54		0398054	50	100	157,00
56-60	2"	0398060	50	100	161,00
63-64		0398064	50	100	184,00
70-73		0398073	50	100	216,00
75-83	2 1/2"	0398078	50	100	223,00
84-89	3"	0398089	50	100	253,00
90-95		0398095	50	100	266,00
100-105		0398105	50	100	292,00
108-112		0398112	50	100	293,00
114-116	4"	0398116	50	100	304,00
121-125		0398125	25	100	321,00

Anschluß: Stufengewinde M10/12 rund

132-136		03981362	25	100	399,00
137-141	5"	03981412	25	100	422,00
159-163		03981632	25	100	444,00
164-168	6"	03981682	25	100	452,00

Anschluß: Gewinde M12 SW 19

15-20	3/8"	0392014	100	100	187,00
22-28	1/2-3/4"	0392030	100	100	190,00
30-35	1"	0392049	100	100	204,00
38-42	1 1/4"	0392057	50	100	212,00
44-48	1 1/2"	0398448	50	100	212,00
50-54		0398454	50	100	213,00
56-60	2"	0398460	50	100	217,00
63-64		0398464	50	100	240,00
70-73		0398473	50	100	272,00
75-80	2 1/2"	0398480	50	100	279,00
84-89	3"	0398489	50	100	309,00
90-95		0398495	50	100	322,00
100-105		0398505	50	100	348,00
108-112		0392219	50	100	349,00
114-116	4"	0398516	50	100	360,00
121-125		0398525	25	100	377,00



■ Omnia-Rohrschelle MB mit Schalldämmeinlage **SILICON**

Abmessung [mm]		Artikel-Nr.	VPE [St]	PE [St]	Euro/PE
Anschluß: Stufengewinde M8/10 SW 13					
15-20	3/8"	0398220	100	100	202,00
22-28	1/2-3/4"	0398228	100	100	224,00
30-35	1"	0398235	100	100	262,00
38-42	1 1/4"	0398242	50	100	318,00
44-48	1 1/2"	0398248	50	100	318,00
50-54		0398254	50	100	361,00
56-60	2"	0398260	50	100	361,00
63-64		0398264	50	100	396,00
70-73		0398273	50	100	425,00
75-80	2 1/2"	0398278	50	100	472,00
84-89	3"	0398289	50	100	608,00
90-95		0398295	50	100	641,00
100-105		0398305	50	100	688,00
108-112		0398312	50	100	717,00
114-116	4"	0398316	50	100	759,00
121-125		0398325	25	100	791,00

Anschluß: Stufengewinde M10/12 rund

132 - 136		1418336	25	100	935,00
137 - 141	5"	1418341	25	100	958,00
159 - 163		1418363	25	100	1.074,00
164 - 168	6"	1418368	25	100	1.096,00

Anschluß: Gewinde M12 SW 19

15-20	3/8"	0392227	100	100	258,00
22-28	1/2-3/4"	0392235	100	100	280,00
30-35	1"	0392243	100	100	318,00
38-42	1 1/4"	0392251	50	100	374,00
44-48	1 1/2"	0397448	50	100	374,00
50-54		0397454	50	100	417,00
56-60	2"	0397460	50	100	417,00
63-64		0397464	50	100	452,00
70-73		0397473	50	100	481,00
75-80	2 1/2"	0397480	50	100	528,00
84-89	3"	0397489	50	100	664,00
90-95		0397495	50	100	697,00
100-105		0397505	50	100	744,00
108-112		0392405	50	100	773,00
114-116	4"	0397516	50	100	815,00
121-125		0397525	25	100	847,00

Schalldämmeinlage:		
Material:	Gummi EPDM/SBR	SILICON
Temperaturbeständigkeit:	- 40 °C bis + 120 °C	- 60 °C bis + 250 °C
Materialstärke:	6 mm	6 mm
Baustoffklasse nach DIN 4102:	B2	B2

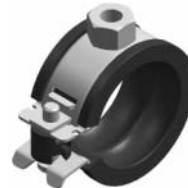

■ Sigma-Gleitrohrschelle mit gleitfähiger Schalldämmeinlage

Abmessung [mm]		Artikel-Nr.	VPE [St]	PE [St]	Euro/PE
Anschluß: Gewinde M8					
12		14520121	100	100	142,00
15		14520151	100	100	143,00
16		14520161	100	100	146,00
18		14520181	100	100	146,00
20		14520201	100	100	148,00
22		14520221	50	100	151,00
25		14520251	50	100	157,00
28		14520281	50	100	161,00
32		14520321	50	100	164,00
35		14520351	50	100	168,00
38		14520381	50	100	168,00
40		14520401	50	100	169,00
42		14520421	50	100	172,00
46		14520461	50	100	181,00



■ Omnia-Gleitrohrschelle mit gleitfähiger Schalldämmeinlage

Abmessung [mm]		Artikel-Nr.	VPE [St]	PE [St]	Euro/PE
Anschluß: Stufengewinde M8/10					
50		0387250	50	100	282,00
52		0387252	50	100	286,00
54		0387254	50	100	286,00
56		0387256	50	100	286,00
63		0387263	50	100	296,00
65		0387265	50	100	296,00
69		0387269	50	100	307,00
75		0387275	50	100	314,00
77		0387277	50	100	317,00
81		0387281	50	100	321,00
90		0387290	50	100	375,00
96		0387296	50	100	381,00
110		0387310	50	100	411,00
116		0387316	50	100	424,00

Gleitfähige Schalldämmeinlage	
Material:	Gummi EPDM/SBR
Temperaturbeständigkeit:	- 40 °C bis + 120 °C
Materialstärke:	3 mm
Baustoffklasse nach DIN 4102:	B2



Standardrohrschelle PSM mit Schalldämmeinlage EPDM

Lieferzeit:
Mit Stufengewinde:
 2 Arbeitstage, ab Werk Kupferzell
Mit Gewinde M16 oder Muffe 1/2":
 5 Arbeitstage ab Werk Kupferzell

Abmess. [mm]	Material [mm]	Artikel-Nr.	VPE [St]	PE [St]	Euro/PE	≥ 10 St.	≥ 25 St.
Anschluß: Stufengewinde M8/10							
15-19	25x3,0	0068819	1	100	438,00	395,00	365,00
20-25	25x3,0	0068823	1	100	440,00	396,00	366,00
26-30	25x3,0	0068828	1	100	446,00	401,00	371,00
31-36	25x3,0	0068873	1	100	458,00	412,00	381,00
38-45	25x3,0	0068880	1	100	467,00	421,00	389,00
47-51	25x3,0	0068881	1	100	476,00	428,00	396,00
53-57	25x3,0	0068941	1	100	484,00	436,00	403,00
58-64	25x3,0	00688083	1	100	516,00	465,00	430,00

Anschluß: Stufengewinde M10/12

65-70	30x3,0	0080075	1	100	714,00	643,00	595,00
72-78	30x3,0	0080106	1	100	736,00	663,00	613,00
84-90	30x3,0	0080107	1	100	760,00	684,00	633,00
94-100	30x3,0	0080108	1	100	776,00	698,00	646,00
102-106	30x3,0	0080148	1	100	788,00	709,00	656,00
108-112	30x3,0	0080159	1	100	800,00	720,00	666,00
113-117	30x3,0	0080167	1	100	821,00	739,00	684,00
120-125	35x4,0	0080168	1	100	1.068,00	962,00	890,00
127-132	35x4,0	0080185	1	100	1.122,00	1.010,00	935,00
133-136	35x4,0	0088136	1	100	1.136,00	1.022,00	946,00
137-142	35x4,0	0080192	1	100	1.163,00	1.047,00	969,00
145-150	35x4,0	0080193	1	100	1.230,00	1.107,00	1.025,00
152-156	35x4,0	0080198	1	100	1.242,00	1.118,00	1.035,00
158-163	35x4,0	0088163	1	100	1.286,00	1.157,00	1.071,00
164-168	35x4,0	0080222	1	100	1.292,00	1.163,00	1.076,00
190-194	35x4,0	0080244	1	100	1.457,00	1.312,00	1.214,00
198-203	35x4,0	0080270	1	100	1.562,00	1.406,00	1.301,00
207-213	35x4,0	0080293	1	100	1.588,00	1.429,00	1.323,00
219-223	35x4,0	0080309	1	100	1.637,00	1.474,00	1.364,00
225-230	35x4,0	0088230	1	100	1.653,00	1.488,00	1.377,00
242-246	35x4,0	0080331	1	100	1.722,00	1.550,00	1.435,00
270-275	35x4,0	0080374	1	100	1.856,00	1.670,00	1.546,00

Anschluß: Gewinde M16

102-106	30x3,0	0081620	1	100	845,00	761,00	704,00
108-112	30x3,0	0081639	1	100	857,00	772,00	714,00
113-117	30x3,0	0081652	1	100	879,00	791,00	732,00
120-125	35x4,0	0081646	1	100	1.126,00	1.014,00	938,00
127-132	35x4,0	0081655	1	100	1.180,00	1.062,00	983,00
133-136	35x4,0	0081663	1	100	1.193,00	1.074,00	994,00
137-142	35x4,0	0081668	1	100	1.221,00	1.099,00	1.017,00
145-150	35x4,0	0081670	1	100	1.288,00	1.159,00	1.073,00
152-156	35x4,0	0081674	1	100	1.300,00	1.170,00	1.083,00
158-163	35x4,0	0081701	1	100	1.343,00	1.209,00	1.119,00
164-168	35x4,0	0081710	1	100	1.349,00	1.214,00	1.124,00
190-194	35x4,0	0081750	1	100	1.515,00	1.363,00	1.262,00
198-203	35x4,0	0081756	1	100	1.619,00	1.457,00	1.349,00
207-213	35x4,0	0081786	1	100	1.646,00	1.481,00	1.371,00
219-223	35x4,0	0081797	1	100	1.695,00	1.525,00	1.412,00
225-230	35x4,0	0081809	1	100	1.710,00	1.539,00	1.425,00
242-246	35x4,0	0081826	1	100	1.780,00	1.602,00	1.483,00
270-275	35x4,0	0081867	1	100	1.913,00	1.722,00	1.594,00

Abmess. [mm]	Material [mm]	Artikel-Nr.	VPE [St]	PE [St]	Euro/PE	≥ 10 St.	≥ 25 St.
--------------	---------------	-------------	----------	---------	---------	----------	----------

Anschluß: Muffe 1/2"

102 - 106	30x3,0	0082120	1	100	893,00	804,00	744,00
108 - 112	30x3,0	0082139	1	100	905,00	815,00	754,00
113 - 117	30x3,0	0082151	1	100	927,00	834,00	772,00
120 - 125	35x4,0	0082146	1	100	1.174,00	1.057,00	978,00
127 - 132	35x4,0	0082155	1	100	1.228,00	1.105,00	1.023,00
133 - 136	35x4,0	0082163	1	100	1.241,00	1.117,00	1.034,00
137 - 142	35x4,0	0082168	1	100	1.269,00	1.142,00	1.057,00
145 - 150	35x4,0	0082170	1	100	1.336,00	1.203,00	1.113,00
152 - 156	35x4,0	0082197	1	100	1.348,00	1.213,00	1.123,00
158 - 163	35x4,0	0082201	1	100	1.391,00	1.252,00	1.159,00
164 - 168	35x4,0	0082210	1	100	1.397,00	1.258,00	1.164,00
190 - 194	35x4,0	0082250	1	100	1.563,00	1.407,00	1.302,00
198 - 203	35x4,0	0082254	1	100	1.667,00	1.501,00	1.389,00
207 - 213	35x4,0	0082290	1	100	1.694,00	1.524,00	1.411,00
219 - 223	35x4,0	0082297	1	100	1.743,00	1.569,00	1.452,00
225 - 230	35x4,0	0082309	1	100	1.758,00	1.583,00	1.465,00
242 - 246	35x4,0	0082327	1	100	1.828,00	1.645,00	1.523,00
270 - 275	35x4,0	0082370	1	100	1.961,00	1.765,00	1.634,00



Standardrohrschelle PSM mit Schalldämmeinlage SILICON

Lieferzeit:
Mit Stufengewinde:
 2 Arbeitstage, ab Werk Kupferzell
Mit Gewinde M16 oder Muffe 1/2":
 5 Arbeitstage ab Werk Kupferzell

Abmess. [mm]	Material [mm]	Artikel-Nr.	VPE [St]	PE [St]	Euro/PE	≥ 10 St.	≥ 25 St.
--------------	---------------	-------------	----------	---------	---------	----------	----------

Anschluß: Stufengewinde M8/10

15-19	25x3,0	00695358	1	100	542,00	488,00	452,00
20-25	25x3,0	0069536	1	100	545,00	490,00	454,00
26-30	25x3,0	0069537	1	100	586,00	527,00	488,00
31-36	25x3,0	0069538	1	100	632,00	569,00	527,00
38-45	25x3,0	0069539	1	100	685,00	617,00	571,00
47-51	25x3,0	0069540	1	100	728,00	656,00	607,00
53-57	25x3,0	0069541	1	100	782,00	704,00	652,00
58-64	25x3,0	00695397	1	100	930,00	837,00	775,00

Anschluß: Stufengewinde M10/12

65-70	30x3,0	0083580	1	100	1.115,00	1.003,00	929,00
72-78	30x3,0	0083589	1	100	1.207,00	1.086,00	1.006,00
84-90	30x3,0	0083596	1	100	1.310,00	1.179,00	1.092,00
94-100	30x3,0	0083610	1	100	1.367,00	1.230,00	1.139,00
102-106	30x3,0	0083626	1	100	1.426,00	1.283,00	1.188,00
108-112	30x3,0	0083635	1	100	1.466,00	1.320,00	1.222,00
113-117	30x3,0	0083636	1	100	1.523,00	1.371,00	1.269,00
120-125	35x4,0	0083662	1	100	1.962,00	1.766,00	1.635,00
127-132	35x4,0	0083670	1	100	2.052,00	1.847,00	1.710,00
133-136	35x4,0	0083678	1	100	2.092,00	1.882,00	1.743,00
137-142	35x4,0	0083679	1	100	2.144,00	1.930,00	1.787,00
145-150	35x4,0	0083686	1	100	2.243,00	2.019,00	1.869,00
152-156	35x4,0	0083694	1	100	2.287,00	2.058,00	1.906,00
158-163	35x4,0	0083708	1	100	2.400,00	2.160,00	2.000,00
164-168	35x4,0	0083711	1	100	2.483,00	2.235,00	2.069,00
190-194	35x4,0	0083742	1	100	2.869,00	2.582,00	2.391,00
198-203	35x4,0	0083750	1	100	2.976,00	2.678,00	2.480,00
207-213	35x4,0	0083774	1	100	3.140,00	2.826,00	2.617,00
219-223	35x4,0	0083804	1	100	3.233,00	2.910,00	2.694,00

Fortsetzung →

Abmess. [mm]	Material [mm]	Artikel-Nr.	VPE [St]	PE [St]	Euro/PE	≥ 10 St.	≥ 25 St.
Anschluß: Stufengewinde M10/12							
225-230	35x4,0	0083806	1	100	3.296,00	2.967,00	2.747,00
242-246	35x4,0	0083839	1	100	3.464,00	3.118,00	2.887,00
270-275	35x4,0	0083878	1	100	3.862,00	3.475,00	3.218,00

Anschluß: Gewinde M16							
102-106	30x3,0	0084646	1	100	1.495,00	1.346,00	1.246,00
108-112	30x3,0	0084654	1	100	1.536,00	1.382,00	1.280,00
113-117	30x3,0	0084659	1	100	1.592,00	1.433,00	1.327,00
120-125	35x4,0	0084665	1	100	2.032,00	1.828,00	1.693,00
127-132	35x4,0	0084670	1	100	2.122,00	1.909,00	1.768,00
133-136	35x4,0	0084689	1	100	2.161,00	1.945,00	1.801,00
137-142	35x4,0	0084692	1	100	2.214,00	1.993,00	1.845,00
145-150	35x4,0	0084693	1	100	2.312,00	2.081,00	1.927,00
152-156	35x4,0	0084703	1	100	2.357,00	2.121,00	1.964,00
158-163	35x4,0	0084719	1	100	2.470,00	2.223,00	2.058,00
164-168	35x4,0	0084723	1	100	2.552,00	2.297,00	2.127,00
190-194	35x4,0	0084750	1	100	2.939,00	2.645,00	2.449,00
198-203	35x4,0	0084754	1	100	3.046,00	2.741,00	2.538,00
207-213	35x4,0	0084794	1	100	3.210,00	2.889,00	2.675,00
219-223	35x4,0	0084811	1	100	3.302,00	2.972,00	2.752,00
225-230	35x4,0	0084816	1	100	3.366,00	3.029,00	2.805,00
242-246	35x4,0	0084832	1	100	3.534,00	3.181,00	2.945,00
270-275	35x4,0	0084870	1	100	3.931,00	3.538,00	3.276,00

Anschluß: Muffe 1/2"							
102-106	30x3,0	0085132	1	100	1.543,00	1.389,00	1.286,00
108-112	30x3,0	0085154	1	100	1.584,00	1.426,00	1.320,00
113-117	30x3,0	0085158	1	100	1.640,00	1.476,00	1.367,00
120-125	35x4,0	0085165	1	100	2.080,00	1.872,00	1.733,00
127-132	35x4,0	0085170	1	100	2.170,00	1.953,00	1.808,00
133-136	35x4,0	0085189	1	100	2.209,00	1.988,00	1.841,00
137-142	35x4,0	0085192	1	100	2.262,00	2.036,00	1.885,00
145-150	35x4,0	0085200	1	100	2.360,00	2.124,00	1.967,00
152-156	35x4,0	0085208	1	100	2.405,00	2.164,00	2.004,00
158-163	35x4,0	0085219	1	100	2.518,00	2.266,00	2.098,00
164-168	35x4,0	0085223	1	100	2.600,00	2.340,00	2.167,00
190-194	35x4,0	0085250	1	100	2.987,00	2.688,00	2.489,00
198-203	35x4,0	0085254	1	100	3.094,00	2.784,00	2.578,00
207-213	35x4,0	0085297	1	100	3.258,00	2.932,00	2.715,00
219-223	35x4,0	0085311	1	100	3.350,00	3.015,00	2.792,00
225-230	35x4,0	0085316	1	100	3.414,00	3.073,00	2.845,00
242-246	35x4,0	0085335	1	100	3.582,00	3.224,00	2.985,00
270-275	35x4,0	0085370	1	100	3.979,00	3.581,00	3.316,00

Seite 1/12-13 Artikelgruppe 1



**Standardrohrschelle PSM
ohne Schalldämmeinlage**

Lieferzeit:
Mit Stufengewinde:
2 Arbeitstage, ab Werk Kupferzell
Mit Gewinde M16 oder Muffe 1/2":
5 Arbeitstage ab Werk Kupferzell

Abmess. [mm]	Material [mm]	Artikel-Nr.	VPE [St]	PE [St]	Euro/PE	≥ 10 St.	≥ 25 St.
Anschluß: Stufengewinde M8/10							
12-16	25x3,0	0068835	1	100	432,00	389,00	360,00
20-23	25x3,0	0068838	1	100	358,00	322,00	298,00
25-29	25x3,0	0068837	1	100	364,00	327,00	303,00
30-35	25x3,0	0068836	1	100	372,00	335,00	310,00
36-40	25x3,0	0068841	1	100	377,00	339,00	314,00

Abmess. [mm]	Material [mm]	Artikel-Nr.	VPE [St]	PE [St]	Euro/PE	≥ 10 St.	≥ 25 St.
Anschluß: Stufengewinde M8/10							
41-46	25x3,0	0068847	1	100	382,00	343,00	318,00
48-55	25x3,0	0068856	1	100	390,00	351,00	325,00
57-61	25x3,0	0068863	1	100	395,00	355,00	329,00
63-67	25x3,0	0068882	1	100	401,00	361,00	334,00
70-76	25x3,0	00880769	1	100	520,00	468,00	433,00

Anschluß: Stufengewinde M10/12							
84-90	30x3,0	0088093	1	100	577,00	519,00	481,00
96-102	30x3,0	0088105	1	100	635,00	571,00	529,00
106-112	30x3,0	0088113	1	100	652,00	586,00	543,00
114-118	30x3,0	0088119	1	100	668,00	602,00	557,00
120-124	30x3,0	0088125	1	100	677,00	609,00	564,00
125-129	30x3,0	0088130	1	100	684,00	616,00	570,00
132-137	35x4,0	0088138	1	100	860,00	774,00	717,00
139-144	35x4,0	0088145	1	100	919,00	827,00	766,00
149-154	35x4,0	0088155	1	100	973,00	876,00	811,00
157-162	35x4,0	0088164	1	100	1.018,00	916,00	848,00
164-168	35x4,0	0088169	1	100	1.026,00	923,00	855,00
189-193	35x4,0	0088194	1	100	1.156,00	1.040,00	963,00
195-200	35x4,0	0088201	1	100	1.189,00	1.070,00	991,00
210-215	35x4,0	0088216	1	100	1.244,00	1.120,00	1.037,00
219-225	35x4,0	0088228	1	100	1.264,00	1.137,00	1.053,00
244-250	35x4,0	0088253	1	100	1.355,00	1.219,00	1.129,00
269-273	35x4,0	0088274	1	100	1.382,00	1.244,00	1.152,00

Anschluß: Gewinde M16							
106 - 112	30x3,0	0081607	1	100	709,00	638,00	591,00
114 - 118	30x3,0	0081621	1	100	726,00	653,00	605,00
120 - 124	30x3,0	0081643	1	100	734,00	661,00	612,00
125 - 129	30x3,0	0081645	1	100	742,00	667,00	618,00
132 - 137	35x4,0	0081654	1	100	918,00	826,00	765,00
139 - 144	35x4,0	0081657	1	100	977,00	879,00	814,00
149 - 154	35x4,0	0081667	1	100	1.031,00	928,00	859,00
157 - 162	35x4,0	0081675	1	100	1.075,00	968,00	896,00
164 - 168	35x4,0	0081704	1	100	1.084,00	975,00	903,00
189 - 193	35x4,0	0081739	1	100	1.213,00	1.092,00	1.011,00
195 - 200	35x4,0	0081746	1	100	1.247,00	1.122,00	1.039,00
210 - 215	35x4,0	0081762	1	100	1.302,00	1.172,00	1.085,00
219 - 225	35x4,0	0081790	1	100	1.321,00	1.189,00	1.101,00
244 - 250	35x4,0	0081818	1	100	1.412,00	1.271,00	1.177,00
269 - 273	35x4,0	0081843	1	100	1.440,00	1.296,00	1.200,00

Anschluß: Muffe 1/2"							
106-112	30x3,0	0082109	1	100	757,00	681,00	631,00
114-118	30x3,0	0082123	1	100	774,00	697,00	645,00
120-124	30x3,0	0082144	1	100	782,00	704,00	652,00
125-129	30x3,0	0082152	1	100	790,00	711,00	658,00
132-137	35x4,0	0082153	1	100	966,00	869,00	805,00
139-144	35x4,0	0082157	1	100	1.025,00	922,00	854,00
149-154	35x4,0	0082173	1	100	1.079,00	971,00	899,00
157-162	35x4,0	0082175	1	100	1.123,00	1.011,00	936,00
164-168	35x4,0	0082196	1	100	1.132,00	1.018,00	943,00
189-193	35x4,0	0082237	1	100	1.261,00	1.135,00	1.051,00
195-200	35x4,0	0082247	1	100	1.295,00	1.165,00	1.079,00
210-215	35x4,0	0082261	1	100	1.350,00	1.215,00	1.125,00
219-225	35x4,0	0082291	1	100	1.369,00	1.232,00	1.141,00
244-250	35x4,0	0082320	1	100	1.460,00	1.314,00	1.217,00
269-273	35x4,0	0082342	1	100	1.488,00	1.339,00	1.240,00



Schwerlast-Rohrschelle mit Schalldämmeinlage EPDM

Lieferzeit:
5 Arbeitstage ab Werk Kupferzell

Abmess. [mm]	Material [mm]	Artikel-Nr.	VPE [St]	PE [St]	Euro/PE	≥ 10 St.	≥ 25 St.	
Anschluß: Gewinde M12								
64	50x5,0	0066504	1	100	1.919,00	1.727,00	1.599,00	
76	2 1/2"	50x5,0	0066508	1	100	2.051,00	1.846,00	1.709,00
89	3"	50x5,0	0066510	1	100	2.196,00	1.977,00	1.830,00
108	50x5,0	0066516	1	100	2.429,00	2.186,00	2.024,00	
110	50x5,0	0066532	1	100	2.442,00	2.198,00	2.035,00	
114	4"	50x5,0	0066559	1	100	2.523,00	2.271,00	2.102,00
125	50x5,0	0066583	1	100	2.626,00	2.364,00	2.188,00	
127	50x5,0	0066591	1	100	2.682,00	2.414,00	2.235,00	
133	50x5,0	0066605	1	100	2.718,00	2.447,00	2.265,00	
135	50x5,0	0066613	1	100	2.730,00	2.457,00	2.275,00	
140	5"	50x5,0	0066621	1	100	2.813,00	2.532,00	2.344,00
152	50x5,0	0066648	1	100	2.997,00	2.697,00	2.497,00	
160	50x5,0	0066680	1	100	3.096,00	2.787,00	2.580,00	
165	6"	50x5,0	0066699	1	100	3.125,00	2.813,00	2.604,00
168	50x5,0	0066710	1	100	3.144,00	2.830,00	2.620,00	
177	50x5,0	0066737	1	100	3.266,00	2.939,00	2.721,00	
180	50x5,0	0066753	1	100	3.284,00	2.955,00	2.736,00	
194	50x5,0	0066761	1	100	3.443,00	3.099,00	2.869,00	
200	50x5,0	0066788	1	100	3.831,00	3.448,00	3.192,00	
210	50x5,0	0066818	1	100	3.900,00	3.510,00	3.250,00	
219	8"	50x5,0	0066826	1	100	4.060,00	3.654,00	3.383,00
225	50x5,0	0066842	1	100	4.152,00	3.737,00	3.460,00	
245	50x5,0	0066877	1	100	4.403,00	3.963,00	3.669,00	
267	50x5,0	0066893	1	100	4.690,00	4.221,00	3.908,00	
273	10"	50x5,0	0066907	1	100	4.745,00	4.271,00	3.954,00
280	50x5,0	0066923	1	100	4.828,00	4.345,00	4.023,00	
298	50x5,0	0066931	1	100	5.110,00	4.599,00	4.258,00	
324	12"	50x5,0	0066958	1	100	5.321,00	4.789,00	4.434,00
356	50x5,0	0066966	1	100	5.764,00	5.188,00	4.803,00	
368	50x5,0	0066982	1	100	5.846,00	5.261,00	4.871,00	

Anschluß: Gewinde M16								
64	50x5,0	0071516	1	100	1.989,00	1.790,00	1.657,00	
76	2 1/2"	50x5,0	0071520	1	100	2.121,00	1.909,00	1.767,00
89	3"	50x5,0	0071522	1	100	2.266,00	2.040,00	1.888,00
108	50x5,0	0071528	1	100	2.499,00	2.249,00	2.082,00	
110	50x5,0	0071536	1	100	2.512,00	2.261,00	2.093,00	
114	4"	50x5,0	0071552	1	100	2.592,00	2.333,00	2.160,00
125	50x5,0	0071587	1	100	2.696,00	2.426,00	2.246,00	
127	50x5,0	0071595	1	100	2.752,00	2.477,00	2.293,00	
133	50x5,0	0071609	1	100	2.788,00	2.509,00	2.323,00	
135	50x5,0	0071617	1	100	2.800,00	2.520,00	2.333,00	
140	5"	50x5,0	0071625	1	100	2.883,00	2.595,00	2.402,00
152	50x5,0	0071641	1	100	3.066,00	2.760,00	2.555,00	
160	50x5,0	0071684	1	100	3.166,00	2.850,00	2.638,00	
165	6"	50x5,0	0071692	1	100	3.195,00	2.875,00	2.662,00
168	50x5,0	0071714	1	100	3.214,00	2.893,00	2.678,00	
177	50x5,0	0071730	1	100	3.335,00	3.002,00	2.779,00	
180	50x5,0	0071757	1	100	3.353,00	3.018,00	2.794,00	
194	50x5,0	0071773	1	100	3.513,00	3.162,00	2.927,00	
200	50x5,0	0071781	1	100	3.900,00	3.510,00	3.250,00	
210	50x5,0	0071803	1	100	3.970,00	3.573,00	3.308,00	

Abmess. [mm]	Material [mm]	Artikel-Nr.	VPE [St]	PE [St]	Euro/PE	≥ 10 St.	≥ 25 St.	
Anschluß: Gewinde M16								
219	8"	50x5,0	0071838	1	100	4.130,00	3.717,00	3.441,00
225	50x5,0	0071846	1	100	4.222,00	3.800,00	3.518,00	
245	50x5,0	0071870	1	100	4.473,00	4.026,00	3.727,00	
267	50x5,0	0071897	1	100	4.760,00	4.284,00	3.966,00	
273	10"	50x5,0	0071900	1	100	4.815,00	4.333,00	4.012,00
280	50x5,0	0071927	1	100	4.898,00	4.408,00	4.081,00	
298	50x5,0	0071935	1	100	5.180,00	4.662,00	4.316,00	
324	12"	50x5,0	0071943	1	100	5.391,00	4.852,00	4.492,00
356	50x5,0	0071978	1	100	5.834,00	5.250,00	4.861,00	
368	50x5,0	0071986	1	100	5.915,00	5.324,00	4.929,00	

Anschluß: Muffe 1/2"								
64	50x5,0	0072503	1	100	2.037,00	1.833,00	1.697,00	
76	2 1/2"	50x5,0	0072508	1	100	2.169,00	1.952,00	1.807,00
89	3"	50x5,0	0072510	1	100	2.314,00	2.083,00	1.928,00
108	50x5,0	0072516	1	100	2.547,00	2.292,00	2.122,00	
110	50x5,0	0072532	1	100	2.560,00	2.304,00	2.133,00	
114	4"	50x5,0	0072559	1	100	2.640,00	2.376,00	2.200,00
125	50x5,0	0072583	1	100	2.744,00	2.469,00	2.286,00	
127	50x5,0	0072591	1	100	2.800,00	2.520,00	2.333,00	
133	50x5,0	0072605	1	100	2.836,00	2.553,00	2.363,00	
135	50x5,0	0072613	1	100	2.848,00	2.563,00	2.373,00	
140	5"	50x5,0	0072621	1	100	2.931,00	2.638,00	2.442,00
152	50x5,0	0072648	1	100	3.114,00	2.803,00	2.595,00	
160	50x5,0	0072680	1	100	3.214,00	2.893,00	2.678,00	
165	6"	50x5,0	0072699	1	100	3.243,00	2.919,00	2.702,00
168	50x5,0	0072710	1	100	3.262,00	2.936,00	2.718,00	
177	50x5,0	0072737	1	100	3.383,00	3.045,00	2.819,00	
180	50x5,0	0072753	1	100	3.401,00	3.061,00	2.834,00	
194	50x5,0	0072761	1	100	3.561,00	3.205,00	2.967,00	
200	50x5,0	0072788	1	100	3.948,00	3.554,00	3.290,00	
210	50x5,0	0072818	1	100	4.018,00	3.616,00	3.348,00	
219	8"	50x5,0	0072826	1	100	4.178,00	3.760,00	3.481,00
225	50x5,0	0072842	1	100	4.270,00	3.843,00	3.558,00	
245	50x5,0	0072877	1	100	4.521,00	4.069,00	3.767,00	
267	50x5,0	0072893	1	100	4.808,00	4.327,00	4.006,00	
273	10"	50x5,0	0072907	1	100	4.863,00	4.377,00	4.052,00
280	50x5,0	0072923	1	100	4.946,00	4.451,00	4.121,00	
298	50x5,0	0072931	1	100	5.228,00	4.705,00	4.356,00	
324	12"	50x5,0	0072958	1	100	5.439,00	4.895,00	4.532,00
356	50x5,0	0072966	1	100	5.882,00	5.294,00	4.901,00	
368	50x5,0	0072982	1	100	5.963,00	5.367,00	4.969,00	

Anschluß: Muffe 1"								
64	50x5,0	0074507	1	100	2.163,00	1.947,00	1.802,00	
76	2 1/2"	50x5,0	0074511	1	100	2.295,00	2.065,00	1.912,00
89	3"	50x5,0	0074513	1	100	2.440,00	2.196,00	2.033,00

Abmess. [mm]	Material [mm]	Artikel-Nr.	VPE [St]	PE [St]	Euro/PE	≥ 10 St.	≥ 25 St.	
Anschluß: Muffe 1"								
108	50x5,0	0074519	1	100	2.673,00	2.406,00	2.227,00	
110	50x5,0	0074535	1	100	2.686,00	2.418,00	2.238,00	
114	4"	50x5,0	0074551	1	100	2.766,00	2.490,00	2.305,00
125	50x5,0	0074586	1	100	2.870,00	2.583,00	2.391,00	
127	50x5,0	0074594	1	100	2.926,00	2.634,00	2.438,00	
133	50x5,0	0074608	1	100	2.962,00	2.666,00	2.468,00	
135	50x5,0	0074616	1	100	2.974,00	2.677,00	2.478,00	
140	5"	50x5,0	0074624	1	100	3.057,00	2.751,00	2.547,00
152	50x5,0	0074640	1	100	3.240,00	2.916,00	2.700,00	
160	50x5,0	0074683	1	100	3.340,00	3.006,00	2.783,00	
165	6"	50x5,0	0074691	1	100	3.369,00	3.032,00	2.807,00
168	50x5,0	0074713	1	100	3.388,00	3.049,00	2.823,00	
177	50x5,0	0074748	1	100	3.509,00	3.158,00	2.924,00	
180	50x5,0	0074756	1	100	3.527,00	3.175,00	2.939,00	
194	50x5,0	0074772	1	100	3.687,00	3.318,00	3.072,00	
200	50x5,0	0074780	1	100	4.074,00	3.667,00	3.395,00	
210	50x5,0	0074802	1	100	4.144,00	3.730,00	3.453,00	
219	8"	50x5,0	0074829	1	100	4.304,00	3.873,00	3.586,00
225	50x5,0	0074845	1	100	4.396,00	3.957,00	3.663,00	
245	50x5,0	0074861	1	100	4.647,00	4.182,00	3.872,00	
267	50x5,0	0074896	1	100	4.934,00	4.440,00	4.111,00	
273	10"	50x5,0	0074918	1	100	4.989,00	4.490,00	4.157,00
280	50x5,0	0074926	1	100	5.072,00	4.565,00	4.226,00	
298	50x5,0	0074934	1	100	5.354,00	4.818,00	4.461,00	
324	12"	50x5,0	0074942	1	100	5.565,00	5.008,00	4.637,00
356	50x5,0	0074969	1	100	6.008,00	5.407,00	5.006,00	
368	50x5,0	0074985	1	100	6.089,00	5.480,00	5.074,00	

Abmess. [mm]	Material [mm]	Artikel-Nr.	VPE [St]	PE [St]	Euro/PE	≥ 10 St.	≥ 25 St.	
Anschluß: Muffe 1 1/4"								
194	50x5,0	0063941	1	100	3.741,00	3.367,00	3.117,00	
200	50x5,0	0063943	1	100	4.128,00	3.716,00	3.440,00	
219	8"	50x5,0	0063951	1	100	4.358,00	3.922,00	3.631,00
245	50x5,0	0063957	1	100	4.701,00	4.231,00	3.917,00	
267	50x5,0	0063961	1	100	4.988,00	4.489,00	4.156,00	
273	10"	50x5,0	0063963	1	100	5.043,00	4.539,00	4.202,00
324	12"	50x5,0	0063978	1	100	5.619,00	5.057,00	4.682,00
356	50x5,0	0063988	1	100	6.062,00	5.456,00	5.051,00	
368	50x5,0	0063990	1	100	6.143,00	5.529,00	5.119,00	

Seite 1/14-17 Artikelgruppe 1



Schwerlast-Rohrschelle mit Schalldämmeinlage SILICON

Lieferzeit:
5 Arbeitstage ab Werk Kupferzell

Abmess. [mm]	Material [mm]	Artikel-Nr.	VPE [St]	PE [St]	Euro/PE	≥ 10 St.	≥ 25 St.	
Anschluß: Gewinde M12								
64	50x5,0	0067500	1	100	2.499,00	2.249,00	2.082,00	
76	2 1/2"	50x5,0	0067504	1	100	2.730,00	2.457,00	2.275,00
89	3"	50x5,0	0067506	1	100	2.984,00	2.685,00	2.486,00
108	50x5,0	0067512	1	100	3.372,00	3.035,00	2.810,00	
110	50x5,0	0067539	1	100	3.404,00	3.063,00	2.836,00	
114	4"	50x5,0	0067555	1	100	3.516,00	3.165,00	2.930,00
125	50x5,0	0067571	1	100	3.712,00	3.341,00	3.093,00	
127	50x5,0	0067598	1	100	3.784,00	3.406,00	3.153,00	
133	50x5,0	0067601	1	100	3.869,00	3.482,00	3.224,00	
135	50x5,0	0067628	1	100	3.897,00	3.507,00	3.247,00	

Abmess. [mm]	Material [mm]	Artikel-Nr.	VPE [St]	PE [St]	Euro/PE	≥ 10 St.	≥ 25 St.	
Anschluß: Gewinde M12								
140	5"	50x5,0	0067636	1	100	4.023,00	3.621,00	3.352,00
152	50x5,0	0067644	1	100	4.306,00	3.876,00	3.588,00	
160	50x5,0	0067687	1	100	4.472,00	4.025,00	3.726,00	
165	6"	50x5,0	0067695	1	100	4.540,00	4.086,00	3.783,00
168	50x5,0	0067717	1	100	4.584,00	4.126,00	3.820,00	
177	50x5,0	0067733	1	100	4.780,00	4.302,00	3.983,00	
180	50x5,0	0067741	1	100	4.824,00	4.342,00	4.020,00	
194	50x5,0	0067768	1	100	5.096,00	4.586,00	4.246,00	
200	50x5,0	0067784	1	100	5.535,00	4.981,00	4.612,00	
210	50x5,0	0067814	1	100	5.688,00	5.120,00	4.740,00	
219	8"	50x5,0	0067822	1	100	5.921,00	5.329,00	4.934,00
225	50x5,0	0067849	1	100	6.064,00	5.458,00	5.053,00	
245	50x5,0	0067873	1	100	6.480,00	5.832,00	5.400,00	
267	50x5,0	0067881	1	100	6.950,00	6.255,00	5.791,00	
273	10"	50x5,0	0067903	1	100	7.054,00	6.349,00	5.878,00
280	50x5,0	0067911	1	100	7.196,00	6.476,00	5.996,00	
298	50x5,0	0067938	1	100	7.625,00	6.863,00	6.354,00	
324	12"	50x5,0	0067954	1	100	8.051,00	7.246,00	6.709,00
356	50x5,0	0067962	1	100	8.758,00	7.882,00	7.298,00	
368	50x5,0	0067989	1	100	8.939,00	8.045,00	7.449,00	

Abmess. [mm]	Material [mm]	Artikel-Nr.	VPE [St]	PE [St]	Euro/PE	≥ 10 St.	≥ 25 St.	
Anschluß: Gewinde M16								
64	50x5,0	0076499	1	100	2.568,00	2.312,00	2.140,00	
76	2 1/2"	50x5,0	0076503	1	100	2.800,00	2.520,00	2.333,00
89	3"	50x5,0	0076505	1	100	3.053,00	2.748,00	2.544,00
108	50x5,0	0076511	1	100	3.442,00	3.098,00	2.868,00	
110	50x5,0	0076538	1	100	3.473,00	3.126,00	2.894,00	
114	4"	50x5,0	0076554	1	100	3.586,00	3.228,00	2.988,00
125	50x5,0	0076589	1	100	3.782,00	3.404,00	3.151,00	
127	50x5,0	0076597	1	100	3.854,00	3.468,00	3.211,00	
133	50x5,0	0076600	1	100	3.939,00	3.545,00	3.282,00	
135	50x5,0	0076619	1	100	3.966,00	3.570,00	3.305,00	
140	5"	50x5,0	0076627	1	100	4.092,00	3.683,00	3.410,00
152	50x5,0	0076643	1	100	4.376,00	3.938,00	3.646,00	
160	50x5,0	0076686	1	100	4.541,00	4.087,00	3.784,00	
165	6"	50x5,0	0076694	1	100	4.610,00	4.149,00	3.841,00
168	50x5,0	0076716	1	100	4.654,00	4.189,00	3.878,00	
177	50x5,0	0076732	1	100	4.850,00	4.365,00	4.041,00	
180	50x5,0	0076759	1	100	4.894,00	4.405,00	4.078,00	
194	50x5,0	0076775	1	100	5.165,00	4.649,00	4.304,00	
200	50x5,0	0076783	1	100	5.604,00	5.044,00	4.670,00	
210	50x5,0	0076805	1	100	5.758,00	5.182,00	4.798,00	
219	8"	50x5,0	0076821	1	100	5.991,00	5.392,00	4.992,00
225	50x5,0	0076848	1	100	6.134,00	5.520,00	5.111,00	
245	50x5,0	0076872	1	100	6.550,00	5.895,00	5.458,00	
267	50x5,0	0076899	1	100	7.019,00	6.317,00	5.849,00	
273	10"	50x5,0	0076902	1	100	7.124,00	6.411,00	5.936,00
280	50x5,0	0076929	1	100	7.265,00	6.539,00	6.054,00	
298	50x5,0	0076937	1	100	7.695,00	6.925,00	6.412,00	
324	12"	50x5,0	0076945	1	100	8.121,00	7.309,00	6.767,00
356	50x5,0	0076961	1	100	8.828,00	7.945,00	7.356,00	
368	50x5,0	0076988	1	100	9.009,00	8.108,00	7.507,00	

Fortsetzung →
Muffe 1/2"
Muffe 1"

**Schwerlast-Rohrschelle mit Schalldämmeinlage
SILICON**

Lieferzeit:
5 Arbeitstage ab Werk Kupferzell

Abmess. [mm]	Material [mm]	Artikel-Nr.	VPE [St]	PE [St]	Euro/PE	≥ 10 St.	≥ 25 St.
Anschluß: Muffe 1/2"							
64	50x5,0	0077506	1	100	2.616,00	2.355,00	2.180,00
76	2 1/2"	50x5,0 0077510	1	100	2.848,00	2.563,00	2.373,00
89	3"	50x5,0 0077512	1	100	3.101,00	2.791,00	2.584,00
108	50x5,0	0077518	1	100	3.490,00	3.141,00	2.908,00
110	50x5,0	0077534	1	100	3.521,00	3.169,00	2.934,00
114	50x5,0	0077550	1	100	3.634,00	3.271,00	3.028,00
125	4"	50x5,0 0077585	1	100	3.830,00	3.447,00	3.191,00
127	50x5,0	0077593	1	100	3.902,00	3.512,00	3.251,00
133	50x5,0	0077607	1	100	3.987,00	3.588,00	3.322,00
135	50x5,0	0077615	1	100	4.014,00	3.613,00	3.345,00
140	5"	50x5,0 0077623	1	100	4.140,00	3.726,00	3.450,00
152	50x5,0	0077631	1	100	4.424,00	3.981,00	3.686,00
160	50x5,0	0077682	1	100	4.589,00	4.130,00	3.824,00
165	6"	50x5,0 0077690	1	100	4.658,00	4.192,00	3.881,00
168	50x5,0	0077712	1	100	4.702,00	4.232,00	3.918,00
177	50x5,0	0077739	1	100	4.898,00	4.408,00	4.081,00
180	50x5,0	0077755	1	100	4.942,00	4.448,00	4.118,00
194	50x5,0	0077771	1	100	5.213,00	4.692,00	4.344,00
200	50x5,0	0077798	1	100	5.652,00	5.087,00	4.710,00
210	50x5,0	0077801	1	100	5.806,00	5.226,00	4.838,00
219	8"	50x5,0 0077828	1	100	6.039,00	5.435,00	5.032,00
225	50x5,0	0077844	1	100	6.182,00	5.564,00	5.151,00
245	50x5,0	0077879	1	100	6.598,00	5.938,00	5.498,00
267	50x5,0	0077895	1	100	7.067,00	6.361,00	5.889,00
273	10"	50x5,0 0077909	1	100	7.172,00	6.455,00	5.976,00
280	50x5,0	0077925	1	100	7.313,00	6.582,00	6.094,00
298	50x5,0	0077933	1	100	7.743,00	6.969,00	6.452,00
324	12"	50x5,0 0077941	1	100	8.169,00	7.352,00	6.807,00
356	50x5,0	0077968	1	100	8.876,00	7.988,00	7.396,00
368	50x5,0	0077984	1	100	9.057,00	8.151,00	7.547,00

Anschluß: Muffe 1"

64	50x5,0	0079498	1	100	2.742,00	2.468,00	2.285,00
76	2 1/2"	50x5,0 0079502	1	100	2.974,00	2.677,00	2.478,00
89	3"	50x5,0 0079504	1	100	3.227,00	2.905,00	2.689,00
108	50x5,0	0079510	1	100	3.616,00	3.255,00	3.013,00
110	50x5,0	0079537	1	100	3.647,00	3.283,00	3.039,00
114	4"	50x5,0 0079553	1	100	3.760,00	3.384,00	3.133,00
125	50x5,0	0079588	1	100	3.956,00	3.560,00	3.296,00
127	50x5,0	0079596	1	100	4.028,00	3.625,00	3.356,00
133	50x5,0	0079618	1	100	4.113,00	3.702,00	3.427,00
135	50x5,0	0079626	1	100	4.140,00	3.726,00	3.450,00
140	5"	50x5,0 0079634	1	100	4.266,00	3.840,00	3.555,00
152	50x5,0	0079642	1	100	4.550,00	4.095,00	3.791,00
160	50x5,0	0079685	1	100	4.715,00	4.244,00	3.929,00
165	6"	50x5,0 0079693	1	100	4.784,00	4.305,00	3.986,00
168	50x5,0	0079715	1	100	4.828,00	4.345,00	4.023,00
177	50x5,0	0079731	1	100	5.024,00	4.521,00	4.186,00
180	50x5,0	0079758	1	100	5.068,00	4.561,00	4.223,00
194	50x5,0	0079774	1	100	5.339,00	4.805,00	4.449,00
200	50x5,0	0079782	1	100	5.778,00	5.201,00	4.815,00
210	50x5,0	0079804	1	100	5.932,00	5.339,00	4.943,00
219	8"	50x5,0 0079820	1	100	6.165,00	5.548,00	5.137,00
225	50x5,0	0079847	1	100	6.308,00	5.677,00	5.256,00

Abmess. [mm]	Material [mm]	Artikel-Nr.	VPE [St]	PE [St]	Euro/PE	≥ 10 St.	≥ 25 St.
--------------	---------------	-------------	----------	---------	---------	----------	----------

Anschluß: Muffe 1"

245	50x5,0	0079871	1	100	6.724,00	6.052,00	5.603,00
267	50x5,0	0079898	1	100	7.193,00	6.474,00	5.994,00
273	10"	50x5,0 0079901	1	100	7.298,00	6.568,00	6.081,00
280	50x5,0	0079928	1	100	7.439,00	6.695,00	6.199,00
298	50x5,0	0079936	1	100	7.869,00	7.082,00	6.557,00
324	12"	50x5,0 0079944	1	100	8.295,00	7.465,00	6.912,00
356	50x5,0	0079960	1	100	9.002,00	8.102,00	7.501,00
368	50x5,0	0079987	1	100	9.183,00	8.265,00	7.652,00

Anschluß: Muffe 1 1/4"

194	50x5,0	0063845	1	100	5.393,00	4.854,00	4.494,00
200	50x5,0	0063847	1	100	5.832,00	5.249,00	4.860,00
219	8"	50x5,0 0063853	1	100	6.219,00	5.597,00	5.182,00
245	50x5,0	0063859	1	100	6.778,00	6.100,00	5.648,00
267	50x5,0	0063863	1	100	7.247,00	6.523,00	6.039,00
273	10"	50x5,0 0063865	1	100	7.352,00	6.617,00	6.126,00
324	12"	50x5,0 0063881	1	100	8.349,00	7.514,00	6.957,00
356	50x5,0	0063891	1	100	9.056,00	8.150,00	7.546,00
368	50x5,0	0063893	1	100	9.237,00	8.313,00	7.697,00



Schwerlast-Rohrschelle ohne Schalldämmeinlage

Lieferzeit:
5 Arbeitstage ab Werk Kupferzell

Abmess. [mm]	Material [mm]	Artikel-Nr.	VPE [St]	PE [St]	Euro/PE	≥ 10 St.	≥ 25 St.
--------------	---------------	-------------	----------	---------	---------	----------	----------

Anschluß: Gewinde M12

64	50x5,0	0066503	1	100	1.371,00	1.234,00	1.142,00
76	2 1/2"	50x5,0 0066507	1	100	1.449,00	1.304,00	1.207,00
89	3"	50x5,0 0066509	1	100	1.563,00	1.407,00	1.302,00
108	50x5,0	0066515	1	100	1.689,00	1.520,00	1.407,00
110	50x5,0	0066518	1	100	1.722,00	1.550,00	1.435,00
114	4"	50x5,0 0066520	1	100	1.752,00	1.577,00	1.460,00
133	50x5,0	0066572	1	100	1.912,00	1.721,00	1.593,00
135	50x5,0	0066592	1	100	1.918,00	1.726,00	1.598,00
140	5"	50x5,0 0066606	1	100	1.967,00	1.771,00	1.639,00
160	50x5,0	0066649	1	100	2.141,00	1.927,00	1.784,00
165	6"	50x5,0 0066682	1	100	2.157,00	1.941,00	1.797,00
168	50x5,0	0066684	1	100	2.166,00	1.950,00	1.805,00
194	50x5,0	0066754	1	100	2.355,00	2.119,00	1.962,00
200	50x5,0	0066762	1	100	2.672,00	2.405,00	2.226,00
210	50x5,0	0066792	1	100	2.709,00	2.438,00	2.257,00
219	8"	50x5,0 0066819	1	100	2.819,00	2.537,00	2.349,00
267	50x5,0	0066881	1	100	3.196,00	2.877,00	2.663,00
273	10"	50x5,0 0066894	1	100	3.232,00	2.909,00	2.693,00
324	12"	50x5,0 0066955	1	100	3.725,00	3.353,00	3.104,00
356	50x5,0	0066965	1	100	4.052,00	3.647,00	3.376,00
368	14"	50x5,0 0066981	1	100	4.098,00	3.689,00	3.415,00

Anschluß: Gewinde M16

64	50x5,0	0071515	1	100	1.440,00	1.296,00	1.200,00
76	2 1/2"	50x5,0 0071519	1	100	1.518,00	1.367,00	1.265,00
89	3"	50x5,0 0071521	1	100	1.632,00	1.469,00	1.360,00
108	50x5,0	0071527	1	100	1.758,00	1.583,00	1.465,00

Fortsetzung →

Abmess. [mm]	Material [mm]	Artikel-Nr.	VPE [St]	PE [St]	Euro/PE	≥ 10 St.	≥ 25 St.
Anschluß: Gewinde M16							
110	50x5,0	0071529	1	100	1.792,00	1.613,00	1.493,00
114	4"	50x5,0 0071530	1	100	1.822,00	1.640,00	1.518,00
133	50x5,0	0071588	1	100	1.982,00	1.784,00	1.651,00
135	50x5,0	0071596	1	100	1.988,00	1.789,00	1.656,00
140	5"	50x5,0 0071610	1	100	2.037,00	1.833,00	1.697,00
160	50x5,0	0071642	1	100	2.211,00	1.990,00	1.842,00
165	6"	50x5,0 0071685	1	100	2.226,00	2.004,00	1.855,00
168	50x5,0	0071687	1	100	2.236,00	2.013,00	1.863,00
194	50x5,0	0071758	1	100	2.424,00	2.182,00	2.020,00
200	50x5,0	0071774	1	100	2.741,00	2.467,00	2.284,00
210	50x5,0	0071784	1	100	2.778,00	2.501,00	2.315,00
219	8"	50x5,0 0071804	1	100	2.889,00	2.600,00	2.407,00
267	50x5,0	0071873	1	100	3.266,00	2.939,00	2.721,00
273	10"	50x5,0 0071898	1	100	3.302,00	2.972,00	2.751,00
324	12"	50x5,0 0071939	1	100	3.795,00	3.415,00	3.162,00
356	50x5,0	0071977	1	100	4.121,00	3.709,00	3.434,00
368	14"	50x5,0 0071979	1	100	4.168,00	3.751,00	3.473,00

Anschluß: Muffe 1/2"							
64	50x5,0	0072502	1	100	1.488,00	1.340,00	1.240,00
76	2 1/2"	50x5,0 0072507	1	100	1.566,00	1.410,00	1.305,00
89	3"	50x5,0 0072509	1	100	1.680,00	1.512,00	1.400,00
108	50x5,0	0072514	1	100	1.806,00	1.626,00	1.505,00
110	50x5,0	0072517	1	100	1.840,00	1.656,00	1.533,00
114	4"	50x5,0 0072519	1	100	1.870,00	1.683,00	1.558,00
133	50x5,0	0072584	1	100	2.030,00	1.827,00	1.691,00
135	50x5,0	0072592	1	100	2.036,00	1.832,00	1.696,00
140	5"	50x5,0 0072606	1	100	2.085,00	1.876,00	1.737,00
160	50x5,0	0072649	1	100	2.259,00	2.033,00	1.882,00
165	6"	50x5,0 0072681	1	100	2.274,00	2.047,00	1.895,00
168	50x5,0	0072683	1	100	2.284,00	2.056,00	1.903,00
194	50x5,0	0072754	1	100	2.472,00	2.225,00	2.060,00
200	50x5,0	0072762	1	100	2.789,00	2.510,00	2.324,00
210	50x5,0	0072791	1	100	2.826,00	2.544,00	2.355,00
219	8"	50x5,0 0072819	1	100	2.937,00	2.643,00	2.447,00
267	50x5,0	0072892	1	100	3.314,00	2.982,00	2.761,00
273	10"	50x5,0 0072894	1	100	3.350,00	3.015,00	2.791,00
324	12"	50x5,0 0072955	1	100	3.843,00	3.459,00	3.202,00
356	50x5,0	0072965	1	100	4.169,00	3.752,00	3.474,00
368	14"	50x5,0 0072967	1	100	4.216,00	3.795,00	3.513,00

Anschluß: Muffe 1"							
64	50x5,0	0074505	1	100	1.614,00	1.453,00	1.345,00
76	2 1/2"	50x5,0 0074510	1	100	1.692,00	1.523,00	1.410,00
89	3"	50x5,0 0074512	1	100	1.806,00	1.626,00	1.505,00
108	50x5,0	0074520	1	100	1.932,00	1.739,00	1.610,00
110	50x5,0	0074522	1	100	1.966,00	1.770,00	1.638,00
114	4"	50x5,0 0074524	1	100	1.996,00	1.797,00	1.663,00
133	50x5,0	0074587	1	100	2.156,00	1.940,00	1.796,00
135	50x5,0	0074595	1	100	2.162,00	1.946,00	1.801,00
140	5"	50x5,0 0074609	1	100	2.211,00	1.990,00	1.842,00
160	50x5,0	0074641	1	100	2.385,00	2.146,00	1.987,00
165	6"	50x5,0 0074684	1	100	2.400,00	2.160,00	2.000,00
168	50x5,0	0074686	1	100	2.410,00	2.169,00	2.008,00
194	50x5,0	0074757	1	100	2.598,00	2.339,00	2.165,00
200	50x5,0	0074773	1	100	2.915,00	2.624,00	2.429,00
210	50x5,0	0074781	1	100	2.952,00	2.657,00	2.460,00
219	8"	50x5,0 0074803	1	100	3.063,00	2.757,00	2.552,00
267	50x5,0	0074874	1	100	3.440,00	3.096,00	2.866,00

Abmess. [mm]	Material [mm]	Artikel-Nr.	VPE [St]	PE [St]	Euro/PE	≥ 10 St.	≥ 25 St.
Anschluß: Muffe 1"							
273	10"	50x5,0 0074897	1	100	3.476,00	3.128,00	2.896,00
324	12"	50x5,0 0074939	1	100	3.969,00	3.572,00	3.307,00
356	50x5,0	0074968	1	100	4.295,00	3.866,00	3.579,00
368	14"	50x5,0 0074970	1	100	4.342,00	3.908,00	3.618,00

Anschluß: Muffe 1 1/4"							
200	50x5,0	0063942	1	100	2.969,00	2.672,00	2.474,00
210	50x5,0	0063947	1	100	3.006,00	2.706,00	2.505,00
219	8"	50x5,0 0063949	1	100	3.117,00	2.805,00	2.597,00
267	50x5,0	0063960	1	100	3.494,00	3.144,00	2.911,00
273	10"	50x5,0 0063962	1	100	3.530,00	3.177,00	2.941,00
324	12"	50x5,0 0063975	1	100	4.023,00	3.621,00	3.352,00
356	50x5,0	0063987	1	100	4.349,00	3.914,00	3.624,00
368	14"	50x5,0 0063989	1	100	4.396,00	3.957,00	3.663,00

Seite 1/21 Artikelgruppe 1



■ Rundstahlbügel

Abmessung [mm]	Gewinde	Artikel-Nr.	VPE [St]	PE [St]	Euro/PE
ohne Muttern					
21,3	1/2"	M8 0507022	1	1	0,49
26,9	3/4"	M8 0507028	1	1	0,56
33,7	1"	M8 0507035	1	1	0,69
42,4	1 1/4"	M8 0507042	1	1	0,79
48,3	1 1/2"	M8 0507048	1	1	0,86
60,3	2"	M10 0507060	1	1	1,20
76,1	2 1/2"	M10 0507076	1	1	1,40
88,9	3"	M10 0507089	1	1	1,45
108,0		M12 0507108	1	1	2,33
114,3	4"	M12 0507114	1	1	2,33
133,0		M12 0507133	1	1	2,62
139,7	5"	M12 0507140	1	1	2,80
159,0		M12 0507159	1	1	3,22
168,3	6"	M12 0507168	1	1	3,60
219,1	8"	M12 0507219	1	1	4,76
273,0	10"	M20 0507273	1	1	15,60
323,9	12"	M20 0507324	1	1	20,35
mit Muttern					
273,0	10"	M20 0503273	1	1	16,50
323,9	12"	M20 0503324	1	1	21,60

Fortsetzung →



■ **CLIPSTAR**
mit Schalldämmeinlage EPDM

Abmessung [mm]	Artikel-Nr.	VPE [St]	PE [St]	Euro/PE
Anschluß: M8				
10	0290106	100	100	61,00
12	0290122	100	100	61,00
15	0290157	100	100	63,00
18	0290181	100	100	63,00
22	0290211	100	100	66,00
28	0290289	100	100	66,00
35	0290351	100	100	83,00
42	0290424	100	100	87,00



■ **DUPLO-Rohrklemme D**
mit Schalldämmeinlage EPDM

Abmessung [mm]		Artikel-Nr.	VPE [St]	PE [St]	Euro/PE
10		0310100	100	100	79,00
12		0310123	100	100	79,00
15		0310158	100	100	79,00
18	3/8"	0310182	100	100	79,00
22	1/2"	0310220	100	100	85,00
28	3/4"	0310298	50	100	91,00
32		0310328	50	100	98,00
35	1"	0310352	50	100	97,00
38		0310387	25	100	116,00
42	1 1/4"	0310425	25	100	117,00
44		0310441	25	100	117,00
48	1 1/2"	0310484	25	100	125,00
54		0310549	25	100	139,00
57		0310573	25	100	141,00
60	2"	0310603	25	100	141,00



■ **DUPLO-Rohrklemme L**
mit Schalldämmeinlage EPDM

Abmessung [mm]		Artikel-Nr.	VPE [St]	PE [St]	Euro/PE
8		0326089	100	100	92,00
10		0326100	100	100	92,00
12		0326127	100	100	93,00
15		0326151	100	100	93,00
18	3/8"	0326186	100	100	93,00
22	1/2"	0326224	100	100	95,00
28	3/4"	0326283	50	100	103,00
32		0326321	50	100	112,00
35	1"	0326356	50	100	112,00
38		0326380	25	100	131,00
42	1 1/4"	0326429	25	100	131,00
44		0326445	25	100	134,00
48	1 1/2"	0326488	25	100	139,00
54		0326542	25	100	139,00
57		0326577	25	100	151,00
60	2"	0326607	25	100	159,00



■ **DUPLO-Doppelrohrklemme**
mit Schalldämmeinlage EPDM

*Lieferzeit:
Auf Anfrage.

Abmessung [mm]	Bügelänge [mm]	Artikel-Nr.	VPE [St]	PE [St]	Euro/PE
8	65	0321080	50	100	219,00
10	65	0321101	50	100	219,00
12	65	0321125	50	100	222,00
15	65	0321168	50	100	225,00
18	65	0321184	50	100	225,00
22	65	0321222	50	100	234,00
28	65	0321281	50	100	241,00
32	65	0321338	50	100	262,00
35	65	0321354	50	100	263,00
38 *	95	0321389	50	100	306,00
42 *	95	0321427	50	100	307,00
44 *	95	0321443	50	100	324,00
48 *	95	0321486	25	100	329,00
54 *	95	0321540	25	100	340,00
57 *	95	0321575	25	100	354,00
60 *	95	0321605	25	100	356,00

Seite 1/26 Artikelgruppe 1

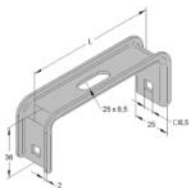

■ DUPLO-Bügel

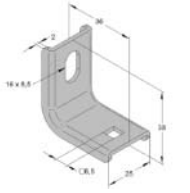

■ DUPLO-Winkel

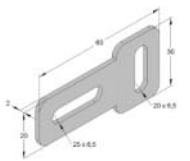

■ DUPLO-Gleitlasche

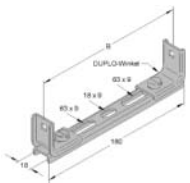

■ Doppelhalter DD mit Schrauben und Muttern

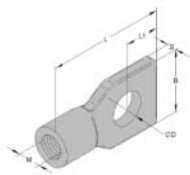

■ DUPLO-Schrauböse mit Innengewinde

Bezeichnung	Maße [mm]	Artikel-Nr.	VPE [St]	PE [St]	Euro/PE
DUPLO-Bügel	65	0322008	1	100	44,00
DUPLO-Bügel	95	0322016	1	100	51,00
DUPLO-Winkel		0327018	1	100	30,00
DUPLO-Gleitlasche		0322032	100	100	24,00
Doppelhalter DD		0322040	50	100	185,00
DUPLO-Schrauböse IG / M6		0350133	100	100	54,00
DUPLO-Schrauböse IG / M8		0350141	100	100	54,00

Seite 1/27 Artikelgruppe 1



■ Sicht-Rohrschelle mit weißer Schalldämmeinlage

Abmessung [mm]	Artikel-Nr.	VPE [St]	PE [St]	Euro/PE	
12	0311120	100	100	124,00	
15	0311150	100	100	129,00	
18	3/8"	0311180	100	100	131,00
22	1/2"	0311220	100	100	139,00
28	3/4"	0311280	50	100	147,00
35	1"	0311340	50	100	161,00
42	1 1/4"	0311420	25	100	183,00

Seite 1/27 Artikelgruppe 1

Abmessung [mm]	Artikel-Nr.	VPE [St]	PE [St]	Euro/PE	
44	0311440	25	100	187,00	
48	1 1/2"	0311480	25	100	197,00
54	0311540	25	100	211,00	
57	0311570	25	100	225,00	
60	2"	0311600	25	100	225,00

Seite 1/28 Artikelgruppe 1

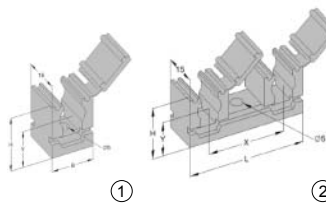

■ CLIPMASTER

Abmessung [mm]	Artikel-Nr.	VPE [St]	PE [St]	Euro/PE [St]
① Einzelclip				
8	0401080	100	100	22,00
10	0401102	100	100	22,00
12	0401129	100	100	22,00
15	0401153	100	100	25,00
18	0401188	100	100	28,00
22	0401226	100	100	38,00
28	0401285	100	100	48,00
35	0401358	100	100	53,00
② Doppelclip				
8	0410071	100	100	39,00
10	0410101	100	100	39,00
12	0410128	100	100	39,00
15	0410152	50	100	46,00
18	0410187	50	100	51,00
22	0410225	50	100	65,00

Seite 1/28 Artikelgruppe 1

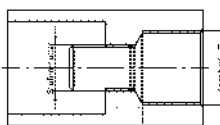

■ Standard-Anschlußadapter

Für Standardrohrschelle PSM und Omnia MB (132 - 168 mm)

Anschluß Innengew.	passend auf Stufenmutter	Artikel-Nr.	VPE [St]	PE [St]	Euro/PE
M16	M10 /12	0830202	1	100	227,00
Muffe 1/2"	M10 /12	0830204	1	100	227,00

Seite 2/1

Artikelgruppe 2

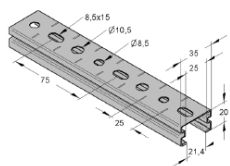

■ Stex- Montageschienen, gelocht, gerändelt
feuerbandverzinkt
(sendzimirverzinkt ca. 20 µm)

Abmessung [mm]	Artikel-Nr.	Länge [m]	VPE [m]	PE [m]	Euro/ PE
35/ 20/ 0,8	1273520	2	6x2	1	3,60
35/ 20/ 0,8	1273523	3	6x3	1	3,60

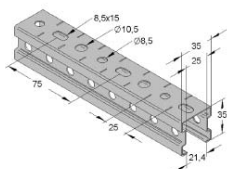

Abmessung [mm]	Artikel-Nr.	Länge [m]	VPE [m]	PE [m]	Euro/ PE
35/ 35/ 1,0	1273538	2	6x2	1	4,75
35/ 35/ 1,0	1273539	3	6x3	1	4,75

Seite 2/2

Artikelgruppe 2

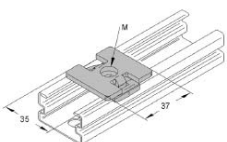

■ Stex

Bezeichnung	Artikel-Nr.	VPE [St]	PE [St]	Euro/PE	≥25 St.	≥50 St.
Stex-M8	1272010	50	1	1,20	1,10	1,00
Stex-M10	1272011	50	1	1,20	1,10	1,00

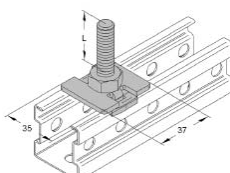

■ Stex- Gewindebolzen

Bezeichnung	Artikel-Nr.	VPE [St]	PE [St]	Euro/PE	≥25 St.	≥50 St.
M8/50	1278050	50	1	1,95	1,75	1,60
M8/70	1278070	50	1	2,00	1,80	1,65
M8/90	1278090	50	1	2,05	1,85	1,70
M8/110	1278110	25	1	2,10	1,90	1,75
M8/130	1278130	25	1	2,20	1,95	1,80
M10/50	1270050	50	1	2,00	1,80	1,65
M10/70	1270070	50	1	2,05	1,85	1,70
M10/90	1270090	50	1	2,10	1,90	1,75
M10/110	1270110	25	1	2,25	2,00	1,85
M10/130	1270130	25	1	2,35	2,15	1,95

Seite 2/3

Artikelgruppe 2

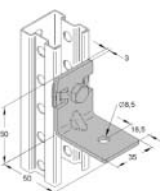

■ Stex- Universalwinkel

Bezeichnung	Artikel-Nr.	VPE [St]	PE [St]	Euro/PE	≥10 St.	≥25 St.
Universalwinkel	1272018	25	1	3,20	2,90	2,65
Universalwinkel-SET	1272022	25	1	4,65	4,20	3,85

Seite 2/3

Artikelgruppe 2

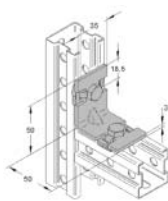

■ Stex-Winkel

Bezeichnung	Artikel-Nr.	VPE [St]	PE [St]	Euro/PE	≥10 St.	≥25 St.
Stex-Winkel	1272012	25	1	4,35	3,90	3,60

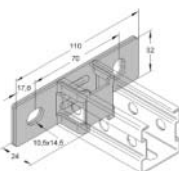

■ Stex-Halter 35/35

Bezeichnung	Artikel-Nr.	VPE [St]	PE [St]	Euro/PE	≥10 St.	≥20 St.
Stex-Halter 35/35	1272021	10	1	5,65	5,10	4,70

Seite 2/4

Artikelgruppe 2

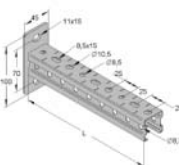

■ Stex- Konsolen

Bezeichnung	Artikel-Nr.	VPE [St]	PE [St]	Euro/PE	≥10 St.	≥25 St.
150 mm	1274150	25	1	6,00	5,40	4,96
225 mm	1274225	25	1	6,55	5,90	5,45
300 mm	1274300	25	1	7,30	6,55	6,05
375 mm	1274375	25	1	8,20	7,35	6,80
450 mm	1274450	25	1	10,30	9,25	8,55
525 mm	1274525	25	1	11,05	9,95	9,20

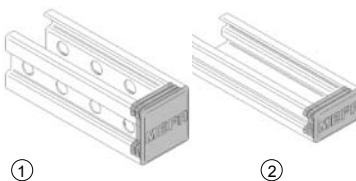

■ Stex- Schutzkappen für Stex-Montageschienen

Bezeichnung	Artikel-Nr.	VPE [St]	PE [St]	Euro/PE	≥25 St.	≥50 St.
① Typ 35/35	1272016	50	1	0,55	0,50	0,44
② Typ 35/20	1272017	50	1	0,50	0,45	0,39

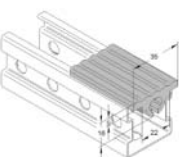

■ Stex- Schienengummi für Stex-Montageschienen

Bezeichnung	Artikel-Nr.	VPE	PE	Euro/PE
Rolle	1272019	20 m	1 m	3,50
Abschnitt 50 mm	1272020	50 St	1 St	0,21

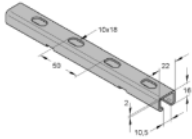

■ **Profilschienen 22/16, gelocht**
Feuer-bandverzinkt (sendzimirverzinkt)

Hinweis: Mindestabnahme 1 VPE

Abmessung [mm]	Artikel-Nr.	Länge [m]	VPE [m]	PE [m]	Euro/ PE
22/16/2,0	0800013	2	10	1	3,95

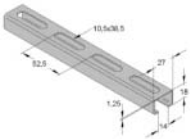

■ **Profilschienen 27/18, gelocht**
Feuer-bandverzinkt (sendzimirverzinkt)

Hinweis: Mindestabnahme 1 VPE

Abmessung [mm]	Artikel-Nr.	Länge [m]	VPE [m]	PE [m]	Euro/ PE
27/18/1,25	1240013	2	10	1	3,05

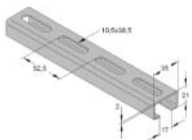

■ **Profilschienen 35/21, gelocht**
Feuer-bandverzinkt (sendzimirverzinkt)

Hinweis: Mindestabnahme 1 VPE

Abmessung [mm]	Artikel-Nr.	Länge [m]	VPE [m]	PE [m]	Euro/ PE
35/21/2,0	0800022	2	2	1	5,20
35/21/2,0	0800026	6	96	1	5,20

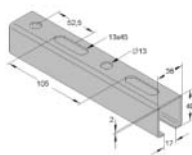

■ **Profilschienen 36/40, gelocht**
Feuer-bandverzinkt (sendzimirverzinkt)

Hinweis: Mindestabnahme 1 VPE

Abmessung [mm]	Artikel-Nr.	Länge [m]	VPE [m]	PE [m]	Euro/ PE
36/40/2,0	0800032	2	2	1	6,15
36/40/2,0	0800036	6	72	1	6,15

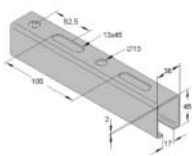

■ **Profilschienen 36/45, gelocht**
Feuer-bandverzinkt (sendzimirverzinkt)

Hinweis: Mindestabnahme 1 VPE

Abmessung [mm]	Artikel-Nr.	Länge [m]	VPE [m]	PE [m]	Euro/ PE
36/45/2,0	0803645	6	48	1	6,70

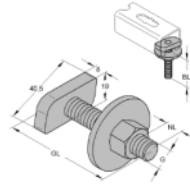

■ **Hammerkopfschraube mit U-Scheibe und Mutter**

Abmessung [mm]	Artikel-Nr.	VPE [St]	PE [St]	Euro/PE	≥50 St.	≥100 St.
----------------	-------------	----------	---------	---------	---------	----------

Für Profilschienen 22/16 mm

M8 x 25	0692320	100	100	64,00	57,00	53,00
M8 x 30	0692328	100	100	65,00	58,00	54,00
M8 x 40	0692330	100	100	86,00	78,00	72,00
M10 x 30	0693323	100	100	77,00	69,00	64,00
M10 x 40	0693340	100	100	103,00	93,00	86,00

Für Profilschienen 27/18 mm

M8 x 20	0695289	100	100	96,00	86,00	80,00
M8 x 30	0695300	100	100	78,00	70,00	65,00
M8 x 40	0695327	100	100	79,00	71,00	66,00

Für Profilschienen

35/21, 36/40, Stex 35/35 und Stex 35/20 mm

M8 x 30	0697044	50	100	106,00	95,00	88,00
M8 x 40	0697051	50	100	107,00	96,00	89,00
M8 x 50	0697060	50	100	108,00	97,00	90,00
M8 x 70	0697075	50	100	112,00	100,00	93,00
M10 x 30	0697540	50	100	114,00	103,00	95,00
M10 x 40	0697560	50	100	118,00	106,00	98,00
M10 x 50	0697570	50	100	120,00	108,00	100,00
M10 x 70	0697590	50	100	128,00	116,00	107,00
M12 x 35	0698040	50	100	158,00	143,00	132,00
M12 x 50	0698050	50	100	166,00	149,00	138,00
M12 x 70	0698070	50	100	173,00	156,00	144,00

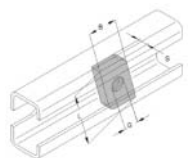

■ **Gewindeplatte**

Abmessung [mm]	Gewinde	Artikel-Nr.	VPE [St]	PE [St]	Euro/PE	≥50 St.	≥100 St.
----------------	---------	-------------	----------	---------	---------	---------	----------

Für Profilschienen 27/18 mm

28 x 15	M8	0750069	100	100	31,00	28,00	26,00
----------------	----	---------	-----	-----	-------	-------	-------

Für Profilschienen

35/21, 36/40, Stex 35/35, Stex 35/20 mm

38 x 17	M8	0750077	100	100	55,00	50,00	46,00
38 x 17	M10	0750085	100	100	64,00	57,00	53,00
38 x 17	M12	0750093	100	100	71,00	64,00	59,00

Seite 2/6

Artikelgruppe 2

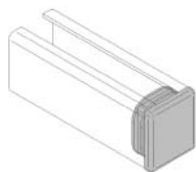

■ **Schutzkappen**
Kunststoff PE, schwarz

Für Profilschiene	Artikel-Nr.	VPE [St]	PE [St]	Euro/PE	≥25 St.	≥50 St.
27 / 18	0809032	50	1	0,30	0,25	0,21
35 / 21	0809012	50	1	0,40	0,35	0,32
36 / 40	0809045	50	1	0,50	0,45	0,39
36 / 45	0809047	50	1	0,50	0,45	0,39

Seite 2/7

Artikelgruppe 2

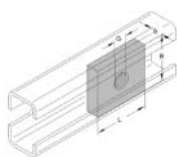

■ **4-Kt.-Gewindeplatte, verzinkt**

Abmessung [mm]	Gewinde	Artikel-Nr.	VPE [St]	PE [St]	Euro/PE	≥50 St.	≥100 St.
Für Profilschienenbreite 22 mm (nicht geeignet für Stex 35)							
17 x 17 x 5	M6	0740012	100	100	14,00	13,00	12,00
17 x 17 x 5	M8	0740020	100	100	14,00	13,00	12,00
17 x 17 x 5	M10	0740039	100	100	14,00	13,00	12,00

Für Profilschienenbreite 27, 35, 36 mm (nicht geeignet für Stex 35)

30 x 22 x 6	M8	0750808	100	100	53,00	48,00	44,00
30 x 22 x 6	M10	0750810	100	100	53,00	48,00	44,00

Abmessung [mm]	Gewinde	Artikel-Nr.	VPE [St]	PE [St]	Euro/PE	≥25 St.	≥50 St.
----------------	---------	-------------	----------	---------	---------	---------	---------

Für Profilschienenbreite 35, 36 mm (nicht geeignet für Stex 35)							
35 x 30 x 6	M8	0816112	50	100	108,00	97,00	90,00
35 x 30 x 8	M10	0816120	50	100	114,00	103,00	95,00
35 x 30 x 8	M12	0816138	50	100	114,00	103,00	95,00
35 x 30 x 8	M16	0816146	50	100	122,00	110,00	102,00

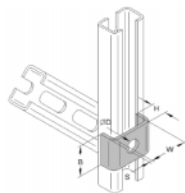

■ **Profilhalter**

Für Profilschienenbreite	Lochung [mm]	Artikel-Nr.	VPE [St]	PE [St]	Euro/PE	≥50 St.	≥100 St.
22 mm	10,5	0809502	100	1	0,55	0,50	0,45
27 mm	10,5	0809504	100	1	0,60	0,50	0,46
35, 36 mm und Stex 35/20, 35/35							
	13,0	0809501	100	1	0,70	0,60	0,55
	10,5	0809503	100	1	0,70	0,60	0,55

Seite 2/7

Artikelgruppe 2

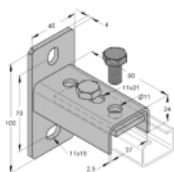

■ **Halter 35**

vormontiert mit
2-Lochgewindeplatte M10
Sechskantschrauben M10

Für Profilschienenbreite 35 und 36 mm und Stex 35/20, 35/35

Bezeichnung	Artikel-Nr.	VPE [St]	PE [St]	Euro/PE	≥10 St.	≥25 St.
längs	080213402	25	1	10,60	9,55	8,80
quer	080213502	25	1	11,30	10,20	9,40

Seite 2/8

Artikelgruppe 2

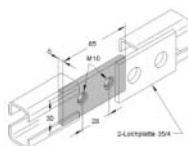

■ **Gewindeplatte 35/4 2-Loch**

Für Profilschienenbreite 35, 36 mm und Stex 35/20, 35/35

Abmessung [mm]	Gewinde	Artikel-Nr.	VPE [St]	PE [St]	Euro/PE	≥25 St.	≥50 St.
65 x 30 x 5	M10	0816092	50	1	1,95	1,75	1,60

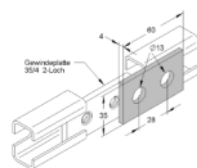

■ **2-Lochplatte 35/4**

Für Profilschienenbreite 35, 36 mm und Stex 35/20, 35/35

Abmessung [mm]	Artikel-Nr.	VPE [St]	PE [St]	Euro/PE	≥10 St.	≥25 St.
60 x 35 x 4	0816086	25	1	1,40	1,25	1,15

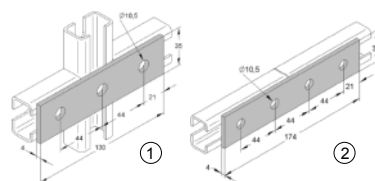

■ **Flachverbinder**

Für Profilschienenbreite 35, 36 mm und Stex 35/20, 35/35

Abmessung [mm]	Artikel-Nr.	VPE [St]	PE [St]	Euro/PE	≥10 St.	≥25 St.
----------------	-------------	----------	---------	---------	---------	---------

① Flachverbinder 35/4 3-Loch						
130 x 35 x 4	0814457	25	1	2,25	2,00	1,85

② Flachverbinder 35/4 4-Loch						
174 x 35 x 4	0814465	25	1	2,65	2,40	2,20

Seite 2/9

Artikelgruppe 2

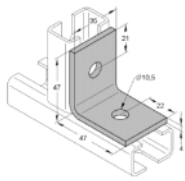

■ Winkel 35/4 2-Loch

Für Profilschienenbreite 35, 36 mm und Stex 35/20, 35/35

Abmessung [mm]	Artikel-Nr.	VPE [St]	PE [St]	Euro/PE	≥50 St.	≥100 St.
Winkel 35/4 2-Loch						
47 x 35 x 4	0814510	100	1	1,60	1,45	1,30

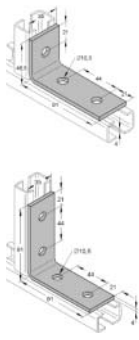

■ Winkel

Für Profilschienenbreite 35, 36 mm und Stex 35/20, 35/35

Abmessung [mm]	Artikel-Nr.	VPE [St]	PE [St]	Euro/PE	≥25 St.	≥50 St.
① Winkel 35/4 3-Loch K						
91 x 35 x 4	0814520	50	1	1,80	1,65	1,50
② Winkel 35/4 4-Loch 90°						
91 x 35 x 4	0814530	50	1	2,30	2,10	1,90
③ Winkel 35/4 4-Loch 135°						
88 x 35 x 4	0814540	50	1	2,50	2,25	2,05

Seite 2/10

Artikelgruppe 2

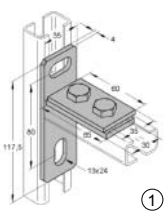

■ Stirnplatte

Für Profilschienenbreite 35, 36 mm und Stex 35/20, 35/35

Abmessung [mm]	Artikel-Nr.	VPE [St]	PE [St]	Euro/PE	≥10 St.	≥25 St.
① Stirnplatte 35/4 quer						
117,5 x 65 x 4	0816453	1	1	7,60	6,85	6,30
② Stirnplatte 35/4						
117,5 x 65 x 4	0816558	1	1	6,85	6,20	5,70

Seite 2/10

Artikelgruppe 2

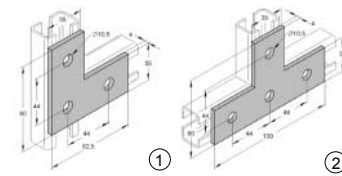

■ Flachverbinder

Für Profilschienenbreite 35, 36 mm und Stex 35/20, 35/35

Abmessung [mm]	Artikel-Nr.	VPE [St]	PE [St]	Euro/PE	≥10 St.	≥25 St.
① Flachverbinder 35/4 L-Form						
85 x 80 x 4	0814430	1	1	5,00	4,50	4,15
② Flachverbinder 35/4 T-Form						
130 x 80 x 4	0814449	1	1	6,60	5,95	5,50

Seite 2/14

Artikelgruppe 2

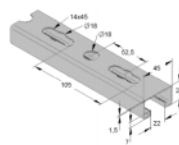

■ Profilschienen 45/26 gelocht, gezahnt

Hinweis: Mindestabnahme 1 VPE

Abmessung [mm]	Artikel-Nr.	Länge [m]	VPE [m]	PE [m]	Euro/PE
Feuer-bandverzinkt (sendzimirverzinkt)					
45/26/1,5 fbv	08202622	2	12	1	6,40
45/26/1,5 fbv	08202662	6	60	1	6,40

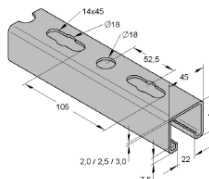

■ Profilschienen 45/40 gelocht, gezahnt

Hinweis: Mindestabnahme 1 VPE

Abmessung [mm]	Artikel-Nr.	Länge [m]	VPE [m]	PE [m]	Euro/PE
Feuer-bandverzinkt (sendzimirverzinkt)					
45/40/2,0 fbv	08204022	2	2	1	7,00
45/40/2,0 fbv	08204062	6	48	1	7,00
45/40/2,5 fbv (IB 071)	0810712	2	2	1	8,55
45/40/2,5 fbv (IB 071)	0810713	6	36	1	8,55
45/40/3,0 fbv (IB 072)	0810721	3	3	1	10,25
45/40/3,0 fbv (IB 073)	0810738	6	6	1	10,25

Feuer-stückverzinkt

45/40/3,0 fsv (IB 074)	0810746	3	3	1	13,20
45/40/3,0 fsv (IB 075)	0810754	6	6	1	13,20

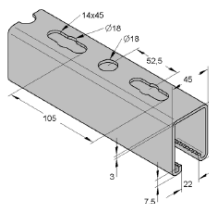

■ Profilschienen 45/60 gelocht, gezahnt

Abmessung [mm]	Artikel-Nr.	Länge [m]	VPE [m]	PE [m]	Euro/PE
Feuer-bandverzinkt (sendzimirverzinkt)					
45/60/3,0 fbv (IB 076)	0810762	6	6	1	15,10
Feuer-stückverzinkt					
45/60/3,0 fsv (IB 077)	0810770	6	6	1	20,70

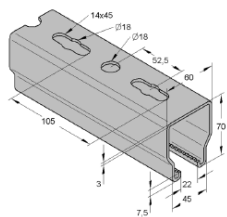

■ Profilschienen 60/70 gelocht, gezahnt

Abmessung [mm] Artikel-Nr. Länge [m] VPE [m] PE [m] Euro/ PE

Feuer-bandverzinkt (sendzimirverzinkt)					
60/70/3,0 fbv (IB 078)	0810787	6	6	1	19,80

Feuer-stückverzinkt					
60/70/3,0 fsv (IB 079)	0810795	6	6	1	25,30

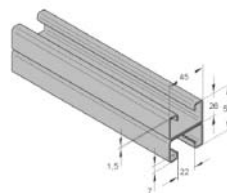

■ Profilschienen 45/52 gelocht, gezahnt

Abmessung [mm] Artikel-Nr. Länge [m] VPE [m] PE [m] Euro/ PE

Feuer-bandverzinkt (sendzimirverzinkt)					
45/52/1,5 D fbv	08215262	6	6	1	20,00

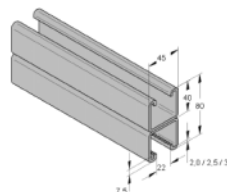

■ Profilschienen 45/80 gelocht, gezahnt

Abmessung [mm] Artikel-Nr. Länge [m] VPE [m] PE [m] Euro/ PE

Feuer-bandverzinkt (sendzimirverzinkt)					
45/80/2,0 D fbv	08217862	6	6	1	22,00

Feuer-bandverzinkt (sendzimirverzinkt)					
45/80/2,5 D fbv	08218062	6	6	1	25,30

Feuer-stückverzinkt					
45/80/3,0 D fsv (IB 081)	0810817	6	6	1	35,40

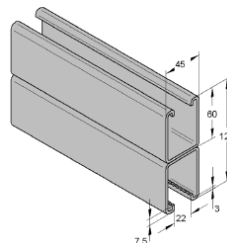

■ Profilschienen 45/120 gelocht, gezahnt

Abmessung [mm] Artikel-Nr. Länge [m] VPE [m] PE [m] Euro/ PE

Feuer-bandverzinkt (sendzimirverzinkt)					
45 /120/3,0 D fbv (IB 082)	0810825	6	6	1	40,50

Feuer-stückverzinkt					
45/120/3,0 D fsv (IB 083)	0810833	6	6	1	45,20

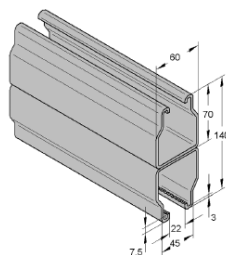

■ Profilschienen 60/140 gelocht, gezahnt

Abmessung [mm] Artikel-Nr. Länge [m] VPE [m] PE [m] Euro/ PE

Feuer-bandverzinkt (sendzimirverzinkt)					
60/140/3,0 D fbv (IB 084)	0810841	6	6	1	48,30

Feuer-stückverzinkt					
60/140/3,0 D fsv (IB 085)	0810858	6	6	1	55,80

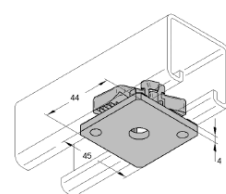

■ Stex 45 Gewindeplatte GP

Für Profilschienenbreite 45 und 60 mm

Bezeichnung	Artikel-Nr.	VPE [St]	PE [St]	Euro/PE	≥10 St.	≥25 St.
GP M8	1280508	30	1	2,20	1,95	1,80
GP M10	1280510	30	1	2,20	1,95	1,80
GP M12	1280512	30	1	2,20	1,95	1,80

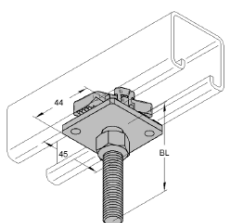

■ Stex 45 Gewindebolzen GB

Für Profilschienenbreite 45 und 60 mm

Bezeichnung	Artikel-Nr.	VPE [St]	PE [St]	Euro/PE	≥10 St.	≥25 St.
GB M8/50	1281050	30	1	2,85	2,55	2,35
GB M8/70	1281070	20	1	2,85	2,55	2,35
GB M8/90	1281090	20	1	2,90	2,60	2,40
GB M8/110	1281110	20	1	3,00	2,70	2,50
GB M8/130	1281130	20	1	3,10	2,80	2,55
GB M10/50	1282050	30	1	2,90	2,60	2,40
GB M10/70	1282070	20	1	2,90	2,60	2,40
GB M10/90	1282090	20	1	3,00	2,70	2,50
GB M10/110	1282110	20	1	3,10	2,80	2,55
GB M10/130	1282130	20	1	3,20	2,90	2,65
GB M12/50	1283050	30	1	3,00	2,70	2,50
GB M12/70	1283070	20	1	3,10	2,80	2,55
GB M12/90	1283090	20	1	3,15	2,85	2,60
GB M12/110	1283110	20	1	3,15	2,85	2,60
GB M12/130	1283130	20	1	3,50	3,15	2,90

Seite 2/16 Artikelgruppe 2 Stex 45

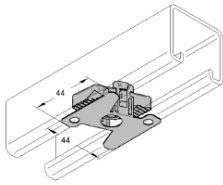

■ Stex 45 Montageplatte MP

Für Profilschienenbreite 45 und 60 mm

Bezeichnung	Artikel-Nr.	VPE [St]	PE [St]	Euro/PE	≥10 St.	≥25 St.
MP M6	1280006	30	1	1,20	1,10	1,00
MP M8	1280008	30	1	1,20	1,10	1,00
MP M10	1280010	30	1	1,20	1,10	1,00
MP M12	1280012	30	1	1,20	1,10	1,00

Seite 2/17 Artikelgruppe 2

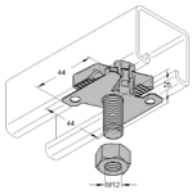

■ Stex 45 Montagebolzen MTB

Für Profilschienenbreite 45 und 60 mm

Bezeichnung	Artikel-Nr.	VPE [St]	PE [St]	Euro/PE	≥10 St.	≥25 St.
MTB M12x40	1280001	30	1	1,75	1,60	1,45

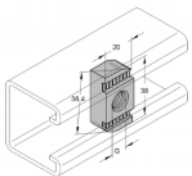

■ Zahnplatte S

Für Profilschienenbreite 45 und 60 mm

Abmessung [mm]	Artikel-Nr.	VPE [St]	PE [St]	Euro/PE	≥50 St.	≥100 St.
34 x 21/M6	0818100	100	1	0,85	0,80	0,70
36 x 20/M8	0818101	100	1	1,15	1,05	0,95
36 x 20/M10	0818102	100	1	1,20	1,10	1,00
36 x 20/M12	0818103	100	1	1,20	1,10	1,00

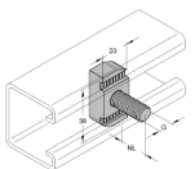

■ Zahnbolzen

Für Profilschienenbreite 45 und 60 mm

Abmessung [mm]	Artikel-Nr.	VPE [St]	PE [St]	Euro/PE	≥50 St.	≥100 St.
M8 x 17,5	(IB693) 0816936	100	1	1,60	1,45	1,30
M10 x 17,5	(IB694) 0816944	100	1	1,60	1,45	1,30
M12 x 22,5	(IB695) 0816952	100	1	1,60	1,45	1,30

Seite 2/- Artikelgruppe 2

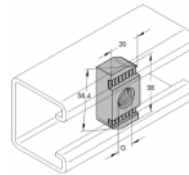

■ Zahnplatte DS

Erhöhter Korrosionsschutz durch Delta-Seal-Beschichtung. Geeignet für den Einsatz mit feuerstückverzinkten Profilen und Bauteilen im Außenbereich.

Für Profilschienenbreite 45 und 60 mm

Abmessung [mm]	Artikel-Nr.	VPE [St]	PE [St]	Euro/PE	≥50 St.	≥100 St.
36 x 20/M8	8989997	100	1	1,30	1,15	1,05
36 x 20/M10	8989998	100	1	1,35	1,20	1,10
36 x 20/M12	8989999	100	1	1,40	1,25	1,15

Seite 2/18 Artikelgruppe 2

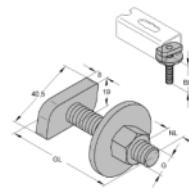

■ Hammerkopfschrauben

Für Profilschienenbreite 45 und 60 mm

Abmessung [mm]	Artikel-Nr.	VPE [St]	PE [St]	Euro/PE	≥25 St.	≥50 St.
M8 x 35	0698735	50	100	132,00	119,00	110,00
M8 x 40	0698740	50	100	133,00	120,00	111,00
M8 x 50	0698750	50	100	134,00	121,00	112,00
M8 x 70	0698770	50	100	138,00	124,00	115,00
M10 x 35	0699235	50	100	150,00	135,00	125,00
M10 x 50	0699250	50	100	156,00	140,00	130,00
M10 x 70	0699270	50	100	162,00	146,00	135,00
M12 x 40	0699740	50	100	174,00	157,00	145,00
M12 x 50	0699750	50	100	179,00	161,00	149,00
M12 x 70	0699770	50	100	186,00	167,00	155,00

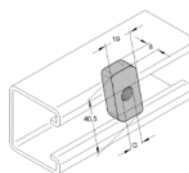

■ Gewindeplatte

Für Profilschienenbreite 45 und 60 mm

Abmessung [mm]	Gewinde	Artikel-Nr.	VPE [St]	PE [St]	Euro/PE	≥50 St.	≥100 St.
40 x 22	M8	0750107	100	100	85,00	77,00	71,00
40 x 22	M10	0750115	100	100	89,00	80,00	74,00
40 x 22	M12	0750123	100	100	94,00	84,00	78,00

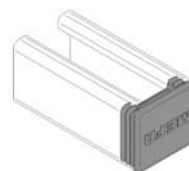

■ Schutzkappen

Kunststoff PE, schwarz

Abmessung [mm]	Artikel-Nr.	VPE [St]	PE [St]	Euro/PE	≥25 St.	≥50 St.
45 / 26	(IB900) 0819005	50	1	0,60	0,55	0,50
45 / 40	(IB903) 0819032	50	1	0,65	0,60	0,53
45 / 60	(IB904) 0819042	50	1	0,70	0,65	0,58
60 / 70	(IB905) 0819050	50	1	1,25	1,15	1,03

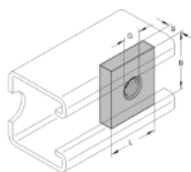

■ 4-Kt.-Gewindeplatte, verzinkt

Abmessung [mm] Gewinde Artikel-Nr. VPE [St] PE [St] Euro/PE ≥25 St. ≥50 St.

Für Profilschienenbreite 45 und 60 mm

35x30x6 (IB611)	M8	0816112	50	100	108,00	97,00	90,00
35x30x8 (IB612)	M10	0816120	50	100	114,00	103,00	95,00
35x30x8 (IB613)	M12	0816138	50	100	114,00	103,00	95,00
35x30x8 (IB614)	M16	0816146	50	100	122,00	110,00	102,00

Für Profilschienenbreite 60 mm

(Für die Befestigung am Profilboden)

50x48x8 (IB615)	M8	0816153	50	100	246,00	221,00	205,00
50x48x8 (IB616)	M10	0816165	50	100	246,00	221,00	205,00
50x48x8 (IB617)	M12	0816177	50	100	246,00	221,00	205,00
50x48x8 (IB618)	M16	0816186	50	100	246,00	221,00	205,00

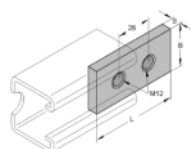

■ 2-Loch-Gewindeplatte

Für Profilschienenbreite 45 und 60 mm

Abmessung [mm] Gewinde Artikel-Nr. VPE [St] PE [St] Euro/PE ≥25 St. ≥50 St.

70x35x8 (IB610)	M12	0816108	50	1	2,40	2,20	2,00
-----------------	-----	---------	----	---	------	------	------

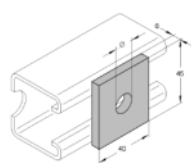

■ Lochplatte

Für Profilschienenbreite 45 und 60 mm

Bezeichnung Artikel-Nr. VPE [St] PE [St] Euro/PE ≥25 St. ≥50 St.

13 mm (IB617)	0814016	50	1	0,80	0,75	0,66
17 mm (IB400)	0814017	50	1	0,80	0,75	0,66

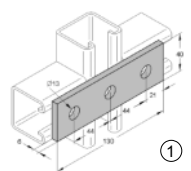

■ Flachverbinder

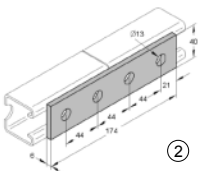

Für Profilschienenbreite 45 und 60 mm

Abmessung [mm] Artikel-Nr. VPE [St] PE [St] Euro/PE ≥10 St. ≥25 St.

① Flachverbinder 40/6 3-Loch

130x40x6 (IB433)	0814331	25	1	2,60	2,35	2,15
------------------	---------	----	---	------	------	------

② Flachverbinder 40/6 4-Loch

174x40x6 (IB434)	0814349	25	1	3,10	2,80	2,55
------------------	---------	----	---	------	------	------

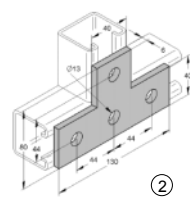
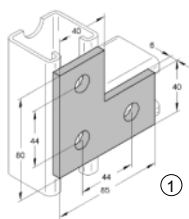

■ Flachverbinder

Für Profilschienenbreite 45 und 60 mm

Abmessung [mm] Artikel-Nr. VPE [St] PE [St] Euro/PE ≥10 St. ≥25 St.

① Flachverbinder 40/6 L-Form

85x80x6 (IB430)	0814307	1	1	5,60	5,00	4,65
-----------------	---------	---	---	------	------	------

② Flachverbinder 40/6 T-Form

130x80x6 (IB431)	0814315	1	1	7,30	6,60	6,10
------------------	---------	---	---	------	------	------

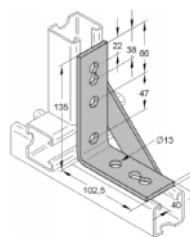
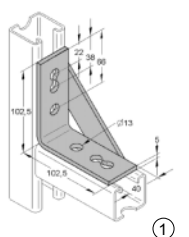

■ Knotendreieck

Für Profilschienenbreite 45 und 60 mm

Abmessung [mm] Artikel-Nr. VPE [St] PE [St] Euro/PE ≥10 St. ≥25 St.

① Knotendreieck 40/5 4-Loch

102,5x40x5 (IB407)	08140700	25	1	8,40	7,60	7,00
--------------------	----------	----	---	------	------	------

② Knotendreieck 40/5 5-Loch

135x40x5 (IB417)	08141700	1	1	9,70	8,75	8,10
------------------	----------	---	---	------	------	------

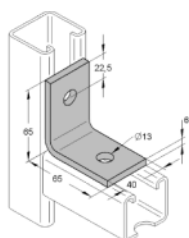

■ Winkel 40/6 2-Loch

Für Profilschienenbreite 45 und 60 mm

Abmessung [mm] Artikel-Nr. VPE [St] PE [St] Euro/PE ≥25 St. ≥50 St.

Winkel 40/6 2-Loch

65x40x6 (IB402)	0814024	50	1	2,00	1,80	1,65
-----------------	---------	----	---	------	------	------

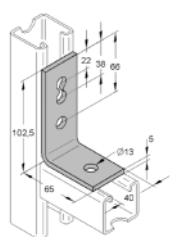

■ Winkel 40/5 3-Loch L

Abmessung [mm] Artikel-Nr. VPE [St] PE [St] Euro/PE ≥10 St. ≥25 St.

Winkel 40/5 3-Loch L

102,5x40x5 (IB403)	08140300	25	1	2,20	1,95	1,80
--------------------	----------	----	---	------	------	------

Seite 2/22

Artikelgruppe 2

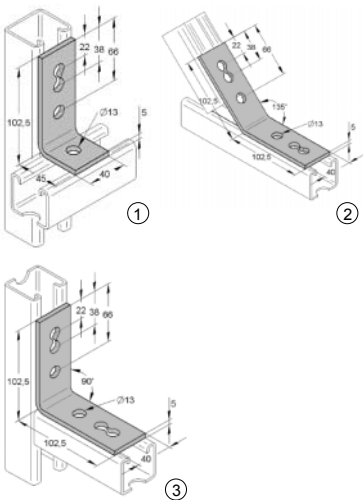

■ Winkel

Für Profilschienenbreite 45 und 60 mm

Abmessung [mm] Artikel-Nr. VPE [St] PE [St] Euro/PE ≥25 St. ≥50 St.

① Winkel 40/5 3-Loch K	102,5x40x5	(IB404) 08140400	50	1	2,20	1,95	1,80
------------------------	------------	------------------	----	---	------	------	------

② Winkel 40/5 4-Loch 135°	102,5x40x5	(IB406) 08140600	50	1	3,10	2,80	2,55
---------------------------	------------	------------------	----	---	------	------	------

③ Winkel 40/5 4-Loch 90°	102,5x40x5	(IB405) 08140500	50	1	3,10	2,80	2,55
--------------------------	------------	------------------	----	---	------	------	------

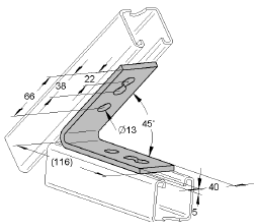

■ Winkel 4-Loch 45°

Abmessung [mm] Artikel-Nr. VPE [St] PE [St] Euro/PE ≥10 St. ≥25 St.

Winkel 40/5 4-Loch 45°	116x40x5	(IB410) 08141000	25	1	3,10	2,80	2,55
------------------------	----------	------------------	----	---	------	------	------

Seite 2/23

Artikelgruppe 2

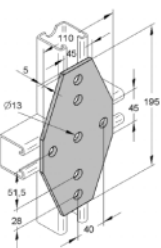

■ Kreuzlasche

Abmessung [mm] Artikel-Nr. VPE [St] PE [St] Euro/PE ≥10 St. ≥25 St.

Kreuzlasche	195x110x5	(IB658) 0816582	1	1	10,20	9,20	8,50
-------------	-----------	-----------------	---	---	-------	------	------

Seite 2/23

Artikelgruppe 2

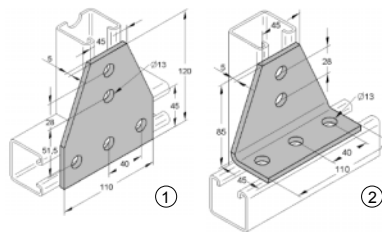

■ T-Laschen

Für Profilschienenbreite 45 und 60 mm

Abmessung [mm] Artikel-Nr. VPE [St] PE [St] Euro/PE ≥10 St. ≥25 St.

① T-Lasche	120x110x5	(IB657) 0816574	1	1	7,15	6,45	5,95
------------	-----------	-----------------	---	---	------	------	------

② T-Lasche 90° gewinkelt	110x85x5	(IB687) 0816870	1	1	9,50	8,55	7,90
--------------------------	----------	-----------------	---	---	------	------	------

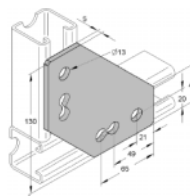

■ Ecklasche 4-Loch

Abmessung [mm] Artikel-Nr. VPE [St] PE [St] Euro/PE ≥10 St. ≥25 St.

Ecklasche 4-Loch	130x40x5	(IB659) 08165900	1	1	5,60	5,05	4,65
------------------	----------	------------------	---	---	------	------	------

Seite 2/24

Artikelgruppe 2

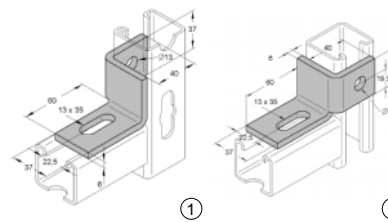

■ Eckwinkel

Bezeichnung Artikel-Nr. VPE [St] PE [St] Euro/PE ≥10 St. ≥25 St.

① rechts	(IB414) 0814142	1	1	7,35	6,60	6,10
② links	(IB415) 0814150	1	1	7,35	6,60	6,10

Seite 2/26 Artikelgruppe 2

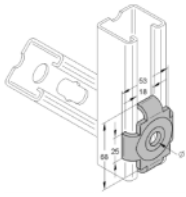

Uni-Profilhalter

Für Profilschienenbreite 45

Bezeichnung	Artikel-Nr.	VPE [St]	PE [St]	Euro/PE	≥50 St.	≥100 St.
Loch-Ø 13,0 mm (IB631)	0816310	100	1	1,35	1,20	1,10
Loch-Ø 17,0 mm (IB632)	0816328	100	1	1,35	1,20	1,10

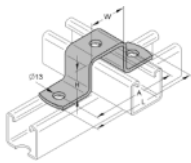

Hutprofil

Bezeichnung	Artikel-Nr.	VPE [St]	PE [St]	Euro/PE	≥10 St.	≥25 St.
-------------	-------------	----------	---------	---------	---------	---------

Für Profilschiene

45/40	(IB624)	0816240	1	1	6,75	6,05	5,60
45/60	(IB625)	0816253	1	1	7,00	6,30	5,80
45/80-D	(IB626)	0816267	1	1	7,30	6,55	6,05
45/120-D	(IB627)	0816274	1	1	7,75	7,00	6,45
60/70	(IB628)	0816288	1	1	7,35	6,60	6,10

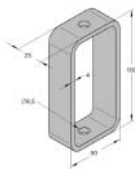

Abhänger 100/50/4 2-Loch

Bezeichnung	Artikel-Nr.	VPE [St]	PE [St]	Euro/PE	≥50 St.	≥100 St.
-------------	-------------	----------	---------	---------	---------	----------

8,5 Loch-Ø	9998541	1	1	4,35	3,90	3,60
-------------------	---------	---	---	------	------	------

Seite 2/27 Artikelgruppe 2

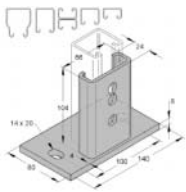

Halter für C-Profile quer

Bezeichnung [Profilschienenbreite mm]	Artikel-Nr.	VPE [St]	PE [St]	Euro/PE	≥10 St.	≥15 St.
---------------------------------------	-------------	----------	---------	---------	---------	---------

45 und 60	(IB204)	08120401	15	1	16,80	15,15	14,00
------------------	---------	----------	----	---	-------	-------	-------

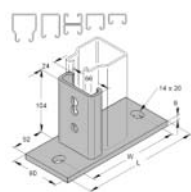

Halter für C-Profile längs

Bezeichnung [Profilschienenbreite mm]	Artikel-Nr.	VPE [St]	PE [St]	Euro/PE	≥10 St.	≥15 St.
---------------------------------------	-------------	----------	---------	---------	---------	---------

45	(IB201)	08120101	15	1	12,40	11,15	10,30
60	(IB218)	08121801	1	1	16,40	14,75	13,65

Seite 2/27 Artikelgruppe 2

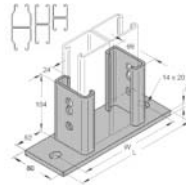

Halter für Doppel-C-Profile

Bezeichnung [für Profilschienen]	Artikel-Nr.	VPE [St]	PE [St]	Euro/PE	≥10 St.	≥15 St.
----------------------------------	-------------	----------	---------	---------	---------	---------

45/80	(IB209)	08120901	1	1	31,45	28,30	26,20
45/120	(IB210)	08121001	1	1	32,90	29,60	27,40
60/140	(IB214)	08121401	1	1	49,20	44,30	41,00

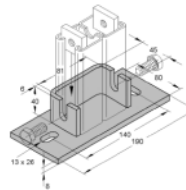

Halter für Doppel-C-Profile (Bodenplatte)

Bezeichnung [für Profilschiene]	Artikel-Nr.	VPE [St]	PE [St]	Euro/PE	≥10 St.	≥15 St.
---------------------------------	-------------	----------	---------	---------	---------	---------

45/80/3,0 D	(IB202)	0812021	1	1	20,90	18,80	17,40
--------------------	---------	---------	---	---	-------	-------	-------

Seite 2/28 Artikelgruppe 2

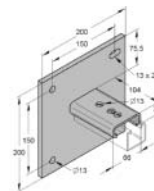

Halter 38/51/150 für C-Profile

Bezeichnung	Artikel-Nr.	VPE [St]	PE [St]	Euro/PE	≥10 St.	≥15 St.
-------------	-------------	----------	---------	---------	---------	---------

38x51x150	(IB970)	08197000	1	1	39,60	35,65	33,00
------------------	---------	----------	---	---	-------	-------	-------

Seite 2/29 Artikelgruppe 2

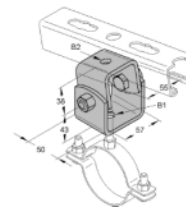

Gelenkhalter mit Anschlußloch

Bezeichnung	Artikel-Nr.	VPE [St]	PE [St]	Euro/PE	≥10 St.	≥25 St.
-------------	-------------	----------	---------	---------	---------	---------

Für Gewindestangen							
M8-M12/M8-M12	(IB207)	0812072	1	1	8,10	7,30	6,75
M8-M12/M16	(IB208)	0812080	1	1	8,80	7,90	7,30
M16/M16	(IB217)	0812177	1	1	10,95	9,85	9,10

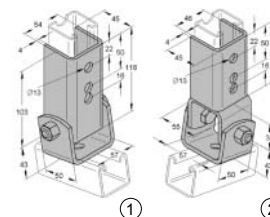

Gelenkhalter für Profilschienenanschluß

Für Profilschienenbreite 45 mm

Bezeichnung	Artikel-Nr.	VPE [St]	PE [St]	Euro/PE	≥10 St.	≥25 St.
-------------	-------------	----------	---------	---------	---------	---------

① längs	(IB206)	08120600	1	1	10,95	9,85	9,10
② quer	(IB211)	08121100	1	1	19,75	17,80	16,45

Seite 2/32

Artikelgruppe 2

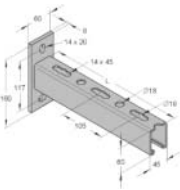

Fertigkonsole
C-Profil 45/60/3,0 mm

Bezeichnung	Länge [mm]	Artikel-Nr.	VPE [St]	PE [St]	Euro/PE	≥10 St.	≥15 St.
Platte längs							
630	630,0	081560630	1	1	38,20	34,35	31,80
735	735,0	081560735	1	1	41,30	37,20	34,40
840	840,0	081560840	1	1	44,80	40,30	37,30

Seite 2/33

Artikelgruppe 2

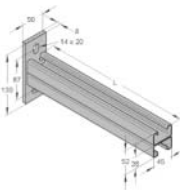

Fertigkonsole
C-Profil 45/52/1,5 D mm

* Auf Anfrage

Bezeichnung	Länge [mm]	Artikel-Nr.	VPE [St]	PE [St]	Euro/PE	≥10 St.	≥15 St.
315	315,0	081552315	1	1	20,05	18,05	16,70
420	420,0	081552420	1	1	26,20	23,55	21,80
525	525,0	081552525	1	1	29,40	26,50	24,50
630	630,0	081552630	1	1	31,20	28,10	26,00
735*	735,0	081552735	1	1	42,75	38,45	35,60
840*	840,0	081552840	1	1	47,20	42,45	39,30

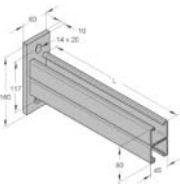

Fertigkonsole
C-Profil 45/80/2,5 D mm

Bezeichnung	Länge [mm]	Artikel-Nr.	VPE [St]	PE [St]	Euro/PE	≥10 St.	≥15 St.
630	630,0	081580630	1	1	46,45	41,80	38,70
735	735,0	081580735	1	1	50,65	45,60	42,20
840	840,0	081580840	1	1	55,45	49,90	46,20
945	945,0	081580945	1	1	57,00	51,30	47,50
1050	1050,0	081581050	1	1	57,60	51,85	48,00

Strebe 45°-T-Profil

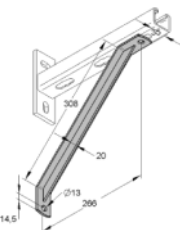

Bezeichnung	Länge [mm]	Artikel-Nr.	VPE [St]	PE [St]	Euro/PE	≥10 St.	≥15 St.
310	310,0	0815101	1	1	13,10	11,80	10,90

Seite 2/34

Artikelgruppe 2

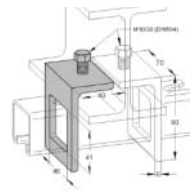

Spannkralle

Bezeichnung	Artikel-Nr.	VPE [St]	PE [St]	Euro/PE	≥25 St.	≥50 St.
-------------	-------------	----------	---------	---------	---------	---------

Für Profilschiene

45/40	(IB650) 0816507	50	1	6,25	5,65	5,20
--------------	-----------------	----	---	------	------	------

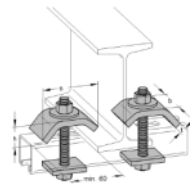

Spannklaue-Montagesatz-Stahl

- bestehend aus:
- 2 Spannklaue
 - 2 Gewindestiften
 - 4 Stahlmuttern
 - 2 Lochplatten
 - 2 U-Scheiben

Bezeichnung	Artikel-Nr.	VPE [St]	PE [St]	Euro/PE	≥10 St.	≥25 St.
-------------	-------------	----------	---------	---------	---------	---------

Für Profilschiene

35	(IB459) 0814595	1	1	5,55	5,00	4,60
36/40, 45/40	(IB652) 0816523	1	1	8,35	7,55	6,95
45/60	(IB952) 0819527	1	1	8,85	7,95	7,35

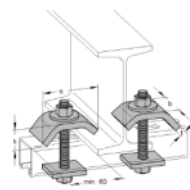

Spannklaue-Montagesatz-Guß

- bestehend aus:
- 2 Spannklaue
 - 2 Gewindestiften
 - 4 Stahlmuttern
 - 2 Lochplatten
 - 2 U-Scheiben

Bezeichnung	Artikel-Nr.	VPE [St]	PE [St]	Euro/PE	≥10 St.	≥25 St.
-------------	-------------	----------	---------	---------	---------	---------

Für Profilschiene

36/40, 45/40	(IB654) 0816549	1	1	11,85	10,65	9,85
45/60	(IB954) 0819543	1	1	12,70	11,40	10,55

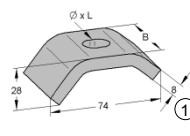

Spannklaue

Bezeichnung	Artikel-Nr.	VPE [St]	PE [St]	Euro/PE	≥10 St.	≥25 St.
-------------	-------------	----------	---------	---------	---------	---------

① **Stahl**

S235JR M10	(IB458) 0814591	1	1	2,20	1,95	1,80
S235JR M12	(IB651) 0816515	1	1	2,30	2,10	1,90
S235JR M16	(IB951) 0819519	1	1	3,00	2,70	2,50

② **Guß**

GTW 45 M12	(IB653) 0816532	1	1	3,60	3,25	3,00
-------------------	-----------------	---	---	------	------	------

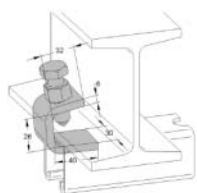

■ Schienenklammer

Bezeichnung	Artikel-Nr.	VPE [St]	PE [St]	Euro/PE	≥10 St.	≥15 St.
Schienenklammer (IB647)	0816477	25	1	6,00	5,40	5,00

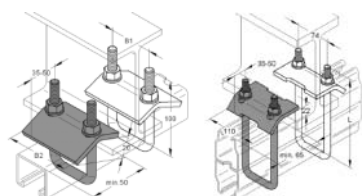

■ Spannbügel-SET und SET M12

Bezeichnung	Artikel-Nr.	VPE [St]	PE [St]	Euro/PE	≥10 St.	≥20 St.
-------------	-------------	----------	---------	---------	---------	---------

Für Profilschienen 35/21, 36/40, Stex 35/35 und 35/20						
M8 36/40	0816710	20	1	3,45	3,10	2,85
Für Profilschiene 45/40, 45/60						
M10 45/60	0816720	20	1	4,50	4,05	3,75
Für Profilschiene 45/80						
M10 45/80	0816730	1	1	5,95	5,35	4,95
Für Profilschiene 45/80, 60/70						
M12 60/70	0816740	1	1	6,00	5,40	5,00
Für Profilschiene 45/120, 60/140						
M12 60/140	0816750	1	1	8,40	7,60	7,00

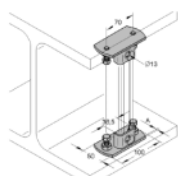

■ Trägerklemmung

Bezeichnung	Artikel-Nr.	VPE [St]	PE [St]	Euro/PE	≥10 St.	≥15 St.
-------------	-------------	----------	---------	---------	---------	---------

Für Profilschienenbreite 35, 36 mm						
35/21	9999687	1	1	9,60	8,65	8,00
36/40	9999695	1	1	9,60	8,65	8,00

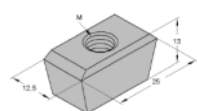

■ Keilmutter für Verbunddecken
Typ HOLORIB, HOESCH

Bezeichnung	Artikel-Nr.	VPE [St]	PE [St]	Euro/PE	≥50 St.	≥100 St.
-------------	-------------	----------	---------	---------	---------	----------

IG M8	(IB971) 0819715	100	1	2,40	2,20	2,00
IG M10	(IB972) 0819722	100	1	2,40	2,20	2,00



■ Festpunkt Typ A
mit Schalldämmeinlage
EPDM/SBR

Rohr-Außen-Ø [mm]	Artikel-Nr.	VPE [St]	PE [St]	Euro/PE
17,2	0020171	1	1	37,90
21,3	0020221	1	1	38,00
26,9	0020271	1	1	38,70
33,7	0020341	1	1	39,10
42,4	0020421	1	1	39,70
48,3	0020481	1	1	39,80
57,0	0020571	1	1	40,30
60,3	0020601	1	1	70,40
76,1	0020761	1	1	74,10
88,9	0020891	1	1	76,60
108,0	0021081	1	1	79,00
114,3	0021141	1	1	80,20
133,0	0021331	1	1	86,50
139,7	0021401	1	1	87,80
159,0	0021591	1	1	92,60



■ Festpunkt Typ B
mit Schalldämmeinlage
EPDM/SBR

Rohr-Außen-Ø [mm]	Artikel-Nr.	VPE [St]	PE [St]	Euro/PE
21,3	0020222	1	1	68,80
26,9	0020272	1	1	69,50
33,7	0020342	1	1	69,90
42,4	0020422	1	1	70,50
48,3	0020482	1	1	70,70
57,0	0020572	1	1	71,30
60,3	0020602	1	1	119,40
76,1	0020762	1	1	124,00
88,9	0020892	1	1	126,50
108,0	0021082	1	1	128,90
114,3	0021142	1	1	130,10
133,0	0021332	1	1	139,60
139,7	0021402	1	1	141,00
159,0	0021592	1	1	148,00
168,3	0021682	1	1	221,80
194,0	0021942	1	1	225,40
219,1	0022192	1	1	230,60
273,0	0022732	1	1	241,70
323,9	0023242	1	1	243,00
355,6	0023562	1	1	272,40

Seite 3a/2

Artikelgruppe 3



■ **Festpunkt Typ A
mit Schalldämmeinlage
SILICON**

Rohr-Außen-Ø [mm]	Artikel-Nr.	VPE [St]	PE [St]	Euro/PE
17,2	0030171	1	1	43,40
21,3	0030221	1	1	43,70
26,9	0030271	1	1	44,70
33,7	0030341	1	1	45,40
42,4	0030421	1	1	46,40
48,3	0030481	1	1	46,90
57,0	0030571	1	1	47,80
60,3	0030601	1	1	81,00
76,1	0030761	1	1	90,00
88,9	0030891	1	1	95,00
108,0	0031081	1	1	108,00
114,3	0031141	1	1	112,00
133,0	0031331	1	1	118,00
139,7	0031401	1	1	119,00
159,0	0031591	1	1	130,00



■ **Festpunkt Typ B
mit Schalldämmeinlage
SILICON**

Rohr-Außen-Ø [mm]	Artikel-Nr.	VPE [St]	PE [St]	Euro/PE
21,3	0030222	1	1	78,90
26,9	0030272	1	1	79,90
33,7	0030342	1	1	80,60
42,4	0030422	1	1	81,60
48,3	0030482	1	1	82,20
57,0	0030572	1	1	83,10
60,3	0030602	1	1	134,00
76,1	0030762	1	1	140,40
88,9	0030892	1	1	144,50
108,0	0031082	1	1	149,10
114,3	0031142	1	1	151,00
133,0	0031332	1	1	162,60
139,7	0031402	1	1	164,70
159,0	0031592	1	1	173,90
168,3	0031682	1	1	252,90
194,0	0031942	1	1	259,50
219,1	0032192	1	1	267,50
273,0	0032732	1	1	355,10

Seite 3a/3

Artikelgruppe 3

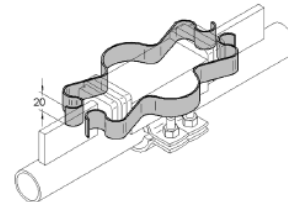

■ **Montageklammer
für Festpunkte**

Bezeichnung	Rohr-Ø [mm]	Artikel-Nr.	VPE [St]	PE [St]	Nettopreis Euro/PE
Größe 1a	21,3-57,0	9000310	2	1	1,70
Größe 1b	21,3-57,0	9000311	2	1	1,70
Größe 2	60,3-159,0	9000312	2	1	2,30
Größe 3	168,1-355,6	9000313	2	1	2,90

Seite 3a/4

Artikelgruppe 3



■ **Festpunkt Typ A
mit Gelenkhalter
mit Schalldämmeinlage
EPDM/SBR**

Lieferzeit:
5 Arbeitstage ab Werk Kupferzell

Rohr-Außen-Ø [mm]	Artikel-Nr.	VPE [St]	PE [St]	Euro/PE
21,3	9999671	1	1	65,30
26,9	9999932	1	1	66,00
33,7	9999835	1	1	66,40
42,4	9999868	1	1	67,00
48,3	9999869	1	1	67,10
57,0	9999864	1	1	67,60
60,3	9999672	1	1	97,70
76,1	9999933	1	1	101,40
88,9	9999865	1	1	103,90
108,0	9999866	1	1	106,30
114,3	9999773	1	1	107,50
133,0	9999772	1	1	113,80
139,7	9999673	1	1	115,10
159,0	9999674	1	1	119,90

Seite 3a/6

Artikelgruppe 3



■ **Festpunkt A/K
mit Schalldämmeinlage
EPDM/SBR**

Lieferzeit:
5 Arbeitstage ab Werk Kupferzell

Rohr-Außen-Ø [mm]	Artikel-Nr.	VPE [St]	PE [St]	Euro/PE
15,0	0020153	1	1	62,00
17,2	0020173	1	1	62,00
20,0	0020203	1	1	62,00
21,3	0020223	1	1	62,00
22,0	0020233	1	1	62,00
26,9	0020273	1	1	63,00
28,0	0020273	1	1	63,00
30,0	0020343	1	1	64,00
32,0	0020343	1	1	64,00
33,7	0020343	1	1	64,00

Fortsetzung →

Rohr-Außen-Ø [mm]	Artikel-Nr.	VPE [St]	PE [St]	Euro/PE
35,0	0020343	1	1	64,00
40,0	0020403	1	1	65,00
42,4	0020423	1	1	65,00
44,0	0020443	1	1	66,00
48,3	0020483	1	1	66,00
50,0	0020483	1	1	66,00
54,0	0020543	1	1	67,00
60,3	0020603	1	1	112,00
63,0	0020630	1	1	113,00
64,0	0020633	1	1	113,00
70,0	0020703	1	1	118,00
75,0	0020753	1	1	118,00
76,1	0020763	1	1	118,00
88,9	0020893	1	1	124,00
108,0	0021083	1	1	130,00
110,0	0021103	1	1	132,00
114,3	0021143	1	1	132,00
125,0	0021253	1	1	140,00
133,0	0021333	1	1	147,00
135,0	0021353	1	1	147,00
139,7	0021403	1	1	147,00
159,0	0021593	1	1	157,00
160,0	0021603	1	1	157,00

Seite 3a/6

Artikelgruppe 3



**Festpunkt A/K
mit Schalldämmeinlage
EPDM/SBR**

Lieferzeit:
5 Arbeitstage ab Werk Kupferzell

Rohr-Außen-Ø [mm]	Artikel-Nr.	VPE [St]	PE [St]	Euro/PE
15,0	0020155	1	1	74,20
17,2	0020155	1	1	74,20
20,0	0020205	1	1	74,80
21,3	0020215	1	1	74,80
22,0	0020215	1	1	74,80
26,9	0020265	1	1	76,50
28,0	0020265	1	1	76,50
30,0	0020265	1	1	77,80
32,0	0020315	1	1	77,80
33,7	0020315	1	1	77,80
35,0	0020315	1	1	77,80
40,0	0020385	1	1	79,80
42,4	0020385	1	1	79,80
44,0	0020385	1	1	80,50
48,3	0020475	1	1	80,50
50,0	0020475	1	1	80,50
54,0	0020535	1	1	82,20
60,3	0020605	1	1	139,60
63,0	0020635	1	1	141,20
64,0	0020645	1	1	141,20
70,0	0020705	1	1	149,50
75,0	0020755	1	1	149,50
76,1	0020765	1	1	149,50
88,9	0020895	1	1	157,30
108,0	0021085	1	1	166,50
110,0	0021105	1	1	170,40
114,3	0021155	1	1	170,40

Fortsetzung →

Rohr-Außen-Ø [mm]	Artikel-Nr.	VPE [St]	PE [St]	Euro/PE
125,0	0021255	1	1	184,10
133,0	0021335	1	1	184,10
135,0	0021355	1	1	189,00
139,7	0021405	1	1	189,00
159,0	0021595	1	1	227,60
160,0	0021605	1	1	227,60

Seite 3a/7

Artikelgruppe 3



Festpunkt FGL

Notwendig für Montage: • 1 Festpunkt FGL
• 2 FGL-Rohrschellen
• 2 Doppelnippel 1/2"
(s. Artikelgruppe 5)

Rohr-Außen-Ø [mm]	Artikel-Nr.	VPE [St]	PE [St]	Euro/PE	≥ 10 St.	≥ 25 St.
----------------------	-------------	-------------	------------	---------	----------	----------

1) Festpunkt FGL

2 x 1/2"	0770335	1	100	1150,00	---	---
----------	---------	---	-----	---------	-----	-----

2) FGL-Rohrschelle, galv. verzinkt, ohne Schalldämmprofil

Anschluß: Muffe 1/2"

20-23	0069047	1	100	470,00	423,00	392,00
25-28	0069049	1	100	476,00	429,00	397,00
32-35	0069053	1	100	485,00	436,00	404,00
36-40	0069081	1	100	490,00	441,00	408,00
41-46	0069097	1	100	494,00	445,00	412,00

Seite 3a/7

Artikelgruppe 3



Festpunkt FGL schallgedämmt

Notwendig für Montage: • 1 Festpunkt FGL schallg.
• 2 FGL-Rohrschellen
• 2 Doppelnippel 1/2"
(s. Artikelgruppe 5)

Rohr-Außen-Ø [mm]	Artikel-Nr.	VPE [St]	PE [St]	Euro/PE
----------------------	-------------	-------------	------------	---------

Festpunkt FGL (ohne FGL-Schellen, s.o.)

2 x 1/2"	9997700	1	1	25,50
----------	---------	---	---	-------

Seite 3a/8

Artikelgruppe 3

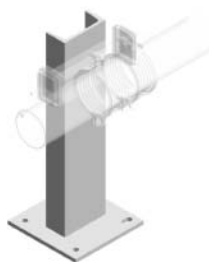

Festpunktconsole

Lieferzeit:
5 Arbeitstage ab Werk Kupferzell

Für Rohr-Außen-Ø [mm]	U-Stahl [mm]	Artikel-Nr.	VPE [St]	PE [St]	Euro/PE
20-168	50/38/750	9997799	1	1	72,00
76-219	120/55/1200	9997858	1	1	112,00

Seite 3a/9

Artikelgruppe 3



■ Schallentkopplungs-Set
Zubehör für Klemmfestpunkt

Maße [mm]	Material Dämmplatte	Artikel-Nr.	VPE [St]	PE [St]	Euro/PE
140/80/6	EPDM	9997852	1	1	8,55

Seite 3b/1

Artikelgruppe 3



■ SIMA-Steckverbinder >S<

DN [mm]	Schrauben [St]	Artikel-Nr.	VPE [St]	PE [St]	Euro/PE
50	1	4470508	100	1	2,45
70	1	4470702	100	1	2,70
80	1	4470808	100	1	3,05
100	1	4471008	50	1	3,05
125	2	4471253	20	1	5,40
150	2	4471504	20	1	6,15
200	CV-Verbinder	4472002	20	1	16,30

Seite 3b/2

Artikelgruppe 3



■ SIMA-Cramp >S<

DN [mm]	Artikel-Nr.	VPE [St]	PE [St]	Euro/PE
50	4472500	20	1	17,65
70	4472705	20	1	18,15
80	4472805	20	1	20,00
100	4473000	10	1	20,15
125	4473256	10	1	25,70
150	4473507	10	1	27,60
200	4474000	5	1	46,70
250	4474508	5	1	89,20



■ Montagewerkzeug SIMA >S<

Bezeichnung	Artikel-Nr.	VPE [St]	PE [St]	Nettopreis Euro/PE
Handeindreher 5/100	5010055	1	1	2,05

Seite 3b/3

Artikelgruppe 3



■ Fallrohrstützenbefestigung für
SML-Fallrohrstützen

- bestehend aus:
- 1 Standardrohrschelle PSM
 - 2 Abstandswinkel
 - 2 Wandausleger bzw. Fertigkonsolen
 - 2 Sechskantschrauben
 - 2 4-kt.-Gewindeplatten

DN [mm]	Artikel-Nr.	VPE [St]	PE [St]	Euro/PE
80	4500800	1	1	18,40
100	4501000	1	1	18,65
125	4501250	1	1	23,95
150	4501500	1	1	24,80
200	4502000	1	1	37,15

Seite 3b/5

Artikelgruppe 3



■ SIMA-CON

DN [mm]	Artikel-Nr.	VPE [St]	PE [St]	Euro/PE
50	4475050	50	1	3,30
70	4475070	50	1	4,55
80	4475080	20	1	7,75
100	4475100	20	1	7,75
125	4475125	10	1	12,15

Seite 3c/4

Artikelgruppe 3

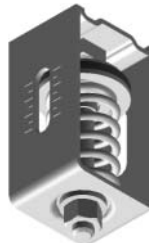

■ Federhänger FH 1

Bezeichnung	Lastbereich [kN]	Artikel-Nr.	VPE [St]	PE [St]	Euro/PE
mit 1 Feder					
FH 1 - 400	0 - 0,39	0794040	1	1	26,40
FH 1 - 600	0 - 0,62	0794060	1	1	26,90
FH 1 - 1000	0 - 1,00	0794100	1	1	27,50
FH 1 - 1300	0 - 1,30	0794130	1	1	34,70
FH 1 - 2100	0 - 2,14	0794210	1	1	36,50
FH 1 - 3000	0 - 3,00	0794300	1	1	37,60



■ Federhänger FH 2

Bezeichnung	Lastbereich [kN]	Artikel-Nr.	VPE [St]	PE [St]	Euro/PE
mit 2 Federn					
FH 2 - 4300	0 - 4,30	0789080	1	1	123,00
FH 2 - 6000	0 - 6,08	0789130	1	1	134,00
FH 2 - 9300	0 - 9,30	0789250	1	1	168,00

Seite 3c/4

Artikelgruppe 3



■ Federtöpfe

Bezeichnung	Lastbereich [kN]	Artikel-Nr.	VPE [St]	PE [St]	Euro/PE
mit 2 Federn					
FT 2 - 100	0,2 - 0,6	0790010	1	1	81,00
FT 2 - 200	0,4 - 1,0	0790020	1	1	86,00
FT 2 - 400	0,8 - 1,5	0790040	1	1	96,00
FT 2 - 500	1,5 - 3,0	0790050	1	1	122,00
FT 2 - 800	2,5 - 5,0	0790080	1	1	152,00
FT 2 - 1300	3,5 - 7,0	0790130	1	1	184,00
FT 2 - 2500	5,0 - 10,0	0790250	1	1	256,00
mit 2 Federn und Gummi-Fußplatte					
FTG 2 - 100	0,2 - 0,6	0792010	1	1	85,00
FTG 2 - 200	0,4 - 1,0	0792020	1	1	91,00
FTG 2 - 400	0,8 - 1,5	0792040	1	1	100,00
FTG 2 - 500	1,5 - 3,0	0792050	1	1	129,00
FTG 2 - 800	2,5 - 5,0	0792080	1	1	160,00
FTG 2 - 1300	3,5 - 7,0	0792130	1	1	190,00
FTG 2 - 2500	5,0 - 10,0	0792250	1	1	367,00

Seite 4/1

Artikelgruppe 4

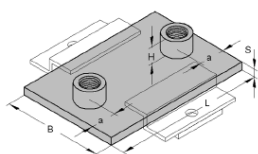

■ Gleitplatten

Abmessung [mm]	Artikel-Nr.	VPE [St]	PE [St]	Euro/PE
150 x 100 x 8				
1 x M16	0771162	1	100	825,00
1 x 1/2"	0771200	1	100	830,00
1 x 3/4"	0771227	1	100	865,00
2 x M16	0771164	1	100	990,00
2 x 1/2"	0771202	1	100	1.035,00
2 x 3/4"	0771229	1	100	1.120,00
200 x 100 x 8				
2 x M16	0771163	1	100	1.090,00
2 x 1/2"	0771201	1	100	1.130,00
2 x 3/4"	0771228	1	100	1.190,00
2 x 1"	0771236	1	100	1.315,00
200 x 150 x 8				
2 x 1/2"	0771331	1	100	2.160,00
250 x 100 x 8				
2 x M16	0771465	1	100	1.260,00
2 x 1/2"	0771503	1	100	1.265,00
2 x 3/4"	0771511	1	100	1.345,00
2 x 1"	0771538	1	100	1.465,00
250 x 200 x 8				
2 x 1/2"	0771707	1	100	3.035,00

Fortsetzung →

Seite 4/1

Artikelgruppe 4

Abmessung [mm]	Artikel-Nr.	VPE [St]	PE [St]	Euro/PE
250 x 200 x 10				
2 x 1/2"	0771710	1	100	4020,00
300 x 200 x 10				
2 x 1"	0771811	1	100	4530,00
300 x 200 x 12				
2 x 1"	0771814	1	100	5560,00
300 x 250 x 12				
2 x 1"	0771817	1	100	6810,00
350 x 200 x 12				
2 x 1 1/4"	0771902	1	100	6505,00
350 x 250 x 12				
2 x 1"	0771911	1	100	7860,00
400 x 250 x 12				
2 x 1 1/4"	0771973	1	100	9005,00

Seite 4/2

Artikelgruppe 4

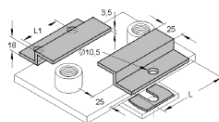

■ Z-Niederhalter

Abmessung [mm]	Anzahl Bohrungen	Artikel-Nr.	VPE [St]	PE [St]	Euro/PE
80	1	0779512	1	100	274,00
80	2	0779513	1	100	328,00
150	2	0779515	1	100	462,00

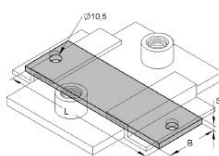

■ Gleitstreifen PA 6.6 für Gleitplatten

Bezeichnung	Maße [mm]	Artikel-Nr.	VPE [St]	PE [St]	Euro/PE
ungelocht					
Standard	1000 x 50 x 5	0779550	1	100	1165,00
2-Loch, für Gleitplattenbreite [mm]					
100	155 x 50 x 5	0779555	1	100	700,00
150	205 x 50 x 5	0779567	1	100	740,00
200	255 x 50 x 5	0779560	1	100	800,00
250	305 x 50 x 5	0779570	1	100	830,00

Seite 4/5-6 Artikelgruppe 4

1) GL 200

	Artikel-Nr.	VPE	PE	Euro/PE
2 x M10	0770527	1	1	7,75
2 x M12	0770535	1	1	7,90
2 x M16	0770562	1	1	9,00
2 x 1/2"	0770608	1	1	10,45

2) GL 200 mit Lasche

	Artikel-Nr.	VPE	PE	Euro/PE
2 x M10	0770638	1	1	9,70
2 x M12	0770539	1	1	9,85
2 x M16	0770566	1	1	10,95
2 x 1/2"	0770615	1	1	12,40

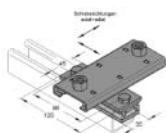

■ Gleitelement radial-axial GL 100 und GL 200

Anschlußgewinde [mm]	Artikel-Nr.	VPE [St]	PE [St]	Euro/PE
----------------------	-------------	----------	---------	---------

GL 100 radial-axial

1 x M10	0770484	1	1	28,80
1 x M12	0770483	1	1	28,85
1 x M16	0770485	1	1	29,45
1 x 1/2"	0770486	1	1	30,20
2 x M10	0770480	1	1	29,25
2 x M12	0770481	1	1	29,50
2 x M16	0770487	1	1	30,80
2 x 1/2"	0770482	1	1	32,25

GL 200 radial-axial

2 x M10	0770471	1	1	30,50
2 x M12	0770470	1	1	30,75
2 x M16	0770472	1	1	31,95
2 x 1/2"	0770473	1	1	33,20

Seite 4/7 Artikelgruppe 4

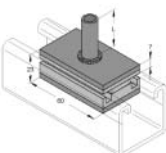

■ Schienengleiter 45 K

Anschlußgewinde [mm]	Artikel-Nr.	VPE [St]	PE [St]	Euro/PE
----------------------	-------------	----------	---------	---------

M8	0770028	1	1	5,70
M10	0770030	1	1	6,00
M12	0770032	1	1	6,30

Seite 4/7 Artikelgruppe 4

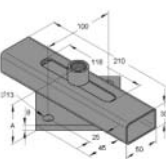

■ Rollenlager

Anschlußgewinde [mm]	Artikel-Nr.	VPE [St]	PE [St]	Euro/PE
----------------------	-------------	----------	---------	---------

Montage stehend				
Stufengew. M10/ 12	0770809	1	1	24,30
Gewinde M16	0770795	1	1	25,60

Seite 4/7 Artikelgruppe 4

Anschlußgewinde [mm]	Artikel-Nr.	VPE [St]	PE [St]	Euro/PE
Muffe 1/2"	0770817	1	1	25,20
Muffe 3/4"	0770787	1	1	26,95

Montage hängend

Stufengew. M10/ 12	0770825	1	1	24,30
Gewinde M16	0770841	1	1	27,00
Muffe 1/2"	0770833	1	1	25,60

Seite 5/1 Artikelgruppe 5

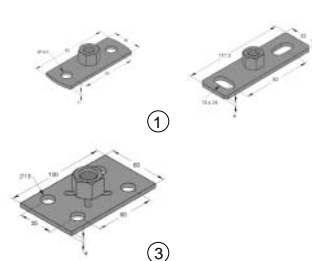

■ Grundplatten

Bezeichnung	Artikel-Nr.	VPE [St]	PE [St]	Euro/PE
-------------	-------------	----------	---------	---------

① 80 x 30 x 3 mm

M8	05900008	50	100	120,00
M10	05900010	50	100	125,00

② Typ I [117 x 35 x 4 mm]

I / M8/10	05900443	50	100	165,00
I / M12	0590061	50	100	165,00
I / M16	0590088	50	100	224,00
I / 1/2"	0590045	50	100	229,00
I / 3/4"	0590053	50	100	274,00

③ Typ II [100 x 60 x 4 mm]

II / M8	0590507	50	100	200,00
II / M10	0590541	50	100	206,00
II / M12	0590525	50	100	213,00
II / M16	0590533	50	100	269,00
II / 1/2"	0590509	50	100	281,00
II / 3/4"	0590517	50	100	321,00
II / 1"	0590568	50	100	378,00

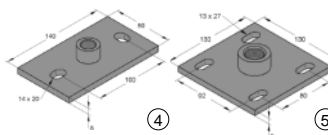

Bezeichnung	Artikel-Nr.	VPE [St]	PE [St]	Euro/PE
-------------	-------------	----------	---------	---------

④ Typ III [150 x 80 x 8 mm]

III / M16	0590601	1	100	659,00
III / 1/2"	0590602	1	100	671,00
III / 3/4"	0590599	1	100	704,00
III / 1"	0590600	1	100	762,00
III / 1 1/4"	0590603	1	100	796,00

⑤ Typ IV [130 x 130 x 8 mm]

IV / M16	0590555	1	100	1.169,00
IV / 1/2"	0590556	1	100	1.185,00
IV / 3/4"	0590557	1	100	1.224,00
IV / 1"	0590558	1	100	1.291,00
IV / 1 1/4"	0590559	1	100	1.335,00

Seite 5/1

Artikelgruppe 5

■ Grundplatten

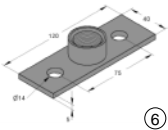

Bezeichnung	Artikel-Nr.	VPE [St]	PE [St]	Euro/PE
⑥ Typ V [120 x 40 x 5 mm]				
V / 1/2"	0590586	50	100	340,00
V / 3/4"	0590587	50	100	370,00
V / 1"	0590588	25	100	430,00

Seite 5/2

Artikelgruppe 5

■ Doppelhalter mit Innengewinde M8

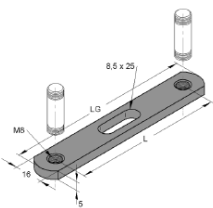

Länge [mm]	Artikel-Nr.	VPE [St]	PE [St]	Euro/PE
65	0763071	100	100	91,00
85	0763098	100	100	99,00
105	0763128	100	100	113,00
160	0763160	100	100	183,00

■ Schraubbolzen mit Außengewinde M8

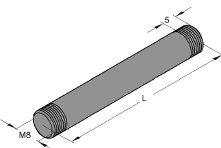

Abmessung [mm]	Artikel-Nr.	VPE [St]	PE [St]	Euro/PE
M8 x 13	0766151	100	100	16,25
M8 x 25	0766259	100	100	16,25
M8 x 35	0766356	100	100	18,70
M8 x 45	0766453	100	100	21,25
M8 x 55	0766550	100	100	23,70
M8 x 65	0766658	100	100	26,20

■ Doppelhalter MD

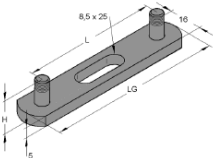

Länge [mm]	Gewinde	Artikel-Nr.	VPE [St]	PE [St]	Euro/PE
65	M6	0760013	50	100	146,00
65	M8	0760048	50	100	156,00
105	M6	0760021	50	100	160,00
105	M8	0760056	50	100	175,00

Seite 5/2

Artikelgruppe 5

■ Doppelhalter VS

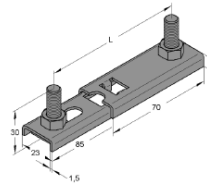

Länge [mm]	Gewindestift	Artikel-Nr.	VPE [St]	PE [St]	Euro/PE
65-110	M8x30	0590199	100	100	160,00

Seite 5/3

Artikelgruppe 5

■ Doppelhalter VSG

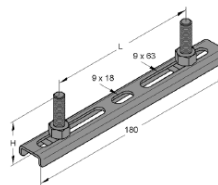

Ausführung	Artikel-Nr.	VPE [St]	PE [St]	Euro/PE
mit Gewindestift				
M8 x 20	0590118	50	100	164,00
M8 x 30	0590126	50	100	170,00
M8 x 40	0590134	50	100	173,00
M8 x 50	0590142	50	100	178,00

■ Hängebügel Typ T

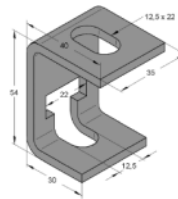

Bezeichnung	Artikel-Nr.	VPE [St]	PE [St]	Euro/PE
Typ T	0781100	100	100	130,00

■ Höhenversteller

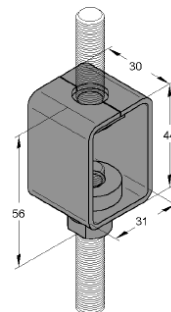

Ausführung	Artikel-Nr.	VPE [St]	PE [St]	Euro/PE
M8 / SMU 8	0783021	50	100	190,00
M10 / SMU 10	0783110	50	100	193,00
M12 / SMU 12	0783251	50	100	201,00

■ Höhenregulierstück

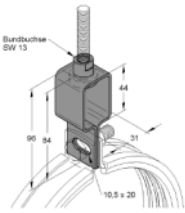

Abmessung [mm]	Artikel-Nr.	VPE [St]	PE [St]	Euro/PE
M8	0780014	50	100	163,00
M10	0780022	50	100	163,00
M12	0780030	50	100	163,00

■ Pendelaufhänger

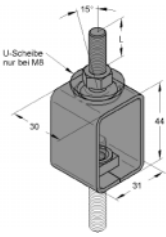

Abmessung [mm]	Artikel-Nr.	VPE [St]	PE [St]	Euro/PE
M8 / M8-40	0784031	50	100	205,00
M10 / M10-40	0784136	50	100	222,00
M12 / M12-40	0784250	50	100	250,00

■ Pendelgelenk

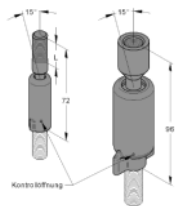

Abmessung [mm]	Gewinde-typ	Artikel-Nr.	VPE [St]	PE [St]	Euro/PE
M8 / M8	IG / AG	0788088	50	100	150,00
M10 / M10	IG / AG	0788108	50	100	165,00
M12 / M12	IG / IG	0788128	50	100	400,00

■ Trapezblechhänger

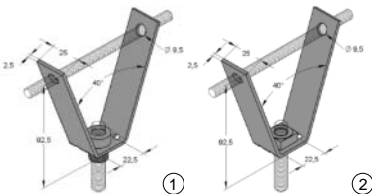

Abmessung [mm]	Artikel-Nr.	VPE [St]	PE [St]	Euro/PE
① Mit montierter Höhenreguliermutter				
MU-B M8	0783803	100	100	165,00
MU-B M10	0783838	100	100	170,00
Bohrung 16,5 mm	0783801	100	100	136,00
② Mit eingeschweißter Mutter				
MU-S M8	0783900	100	100	137,00
MU-S M10	0783935	100	100	148,00
MU-S M12	0783950	100	100	165,00

■ Lochzange für Trapezbleche

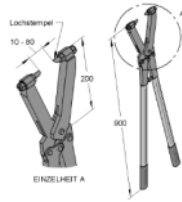

Bezeichnung	Artikel-Nr.	VPE [St]	PE [St]	Euro/PE
Nettopreis				
Lochzange	5020000	1	1	190,00
Ersatz-Lochstempel	5020010	2	1	16,00

■ Gewindehaken



Gewinde	Länge [mm]	Artikel-Nr.	VPE [St]	PE [St]	Euro/PE
M8	130	0592131	50	100	89,00
M10	130	0592132	50	100	136,00
M12	150	0592153	50	100	156,00

■ Schutzkappen, rund schwarz

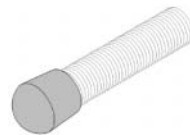

Für Gewinde	Artikel-Nr.	VPE [St]	PE [St]	Euro/PE
M8	0730008	100	100	8,00
M10	0730010	50	100	11,00
M12	0730012	50	100	12,20

■ Abstandswinkel



Bezeichnung	Artikel-Nr.	VPE [St]	PE [St]	Euro/PE
Einfachwinkel				
E 25	0630268	1	100	66,00
E 30	0630306	1	100	68,00
E 35	0630357	1	100	72,00
E 40	0630403	1	100	75,00
E 50	0630500	1	100	81,00
E 60	0630608	1	100	89,00
E 70	0630705	1	100	96,00
E 80	0630802	1	100	100,00
E 90	0630918	1	100	113,00
E 100	0631000	1	100	120,00

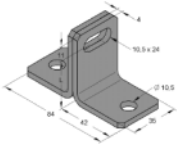

■ Abstandswinkel

Bezeichnung	Artikel-Nr.	VPE [St]	PE [St]	Euro/PE
Doppelwinkel				
D 25	0650250	1	100	174,00
D 30	0650307	1	100	180,00
D 35	0650358	1	100	186,00
D 40	0650404	1	100	193,00
D 50	0650501	1	100	206,00
D 60	0650609	1	100	221,00
D 70	0650706	1	100	233,00
D 80	0650803	1	100	244,00
D 90	0650900	1	100	271,00
D 100	0651001	1	100	283,00
D 120	0651206	1	100	309,00
D 150	0651508	1	100	355,00
D 180	0651796	1	100	397,00
D 200	0652008	1	100	429,00



■ Gewindestifte DIN 976

Gewinde	Länge [mm]	Artikel-Nr.	VPE [St]	PE [St]	Euro/PE
M8	20	0730815	100	100	6,50
	30	0730823	100	100	8,30
	35	0731358	100	100	9,50
	40	0730831	100	100	9,50
	50	0730858	100	100	11,85
	70	0730874	100	100	14,20
	90	0730890	100	100	18,95
M10	110	0730912	100	100	21,85
	140	0730940	100	100	26,00
	160	0730963	100	100	42,55
	20	0731021	100	100	9,50
	25	0731032	100	100	11,30
	30	0731048	100	100	11,85
	35	0733350	100	100	13,00
M12	40	0731056	100	100	14,20
	50	0731064	100	100	16,00
	70	0731072	100	100	21,30
	90	0731099	100	100	27,20
	110	0731110	50	100	33,70
	35	0731234	50	100	22,50
	50	0731250	50	100	27,20
M16	70	0731269	50	100	32,50
	90	0731293	50	100	41,35
	110	0731315	50	100	56,00
	70	0731672	25	100	61,00
	110	0731715	25	100	87,00
	160	0731763	25	100	153,00



■ Gewindestangen DIN 975

Gewinde	Länge [mm]	Artikel-Nr.	VPE [St]	PE [St]	Euro/PE
M8	1.000	0730084	50	1	1,10
M8	2.000	0730289	1	1	2,45
M8	3.000	0730483	1	1	3,85
M10	1.000	0730106	25	1	1,60
M10	2.000	0730300	1	1	3,40
M10	3.000	0730505	1	1	5,40
M12	1.000	0730122	20	1	2,40
M12	2.000	0730327	1	1	4,75
M12	3.000	0730521	1	1	7,55
M16	1.000	0730165	10	1	4,80
M16	2.000	0730378	1	1	9,70
M16	3.000	0730564	1	1	15,20

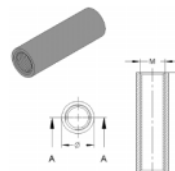

■ Distanzmuffen, rund mit Innengewinde

Gewinde	Länge [mm]	Artikel-Nr.	VPE [St]	PE [St]	Euro/PE
M6	25	0700010	100	100	27,00
M8	30	0700029	100	100	31,00
M10	40	0700037	100	100	57,00
M12	40	0700045	100	100	68,00
M16	50	0700053	25	100	171,00

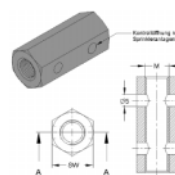

■ Distanzmuffen, sechskant mit Innengewinde

Gewinde	Länge [mm]	Artikel-Nr.	VPE [St]	PE [St]	Euro/PE
Sechskant, mit Innengewinde					
M8	30	0700084	100	100	43,00
M10	40	0700104	50	100	76,00
M12	40	0700126	50	100	97,00
M16	50	0700167	25	100	199,00

Distanzmuffe mit Kontrollöffnung für Sprinklerbau

Gewinde	Länge [mm]	Artikel-Nr.	VPE [St]	PE [St]	Euro/PE
M8	30	0700095	100	100	62,00
M10	40	0700117	50	100	92,00
M12	40	0700133	50	100	124,00
M16	50	0700174	25	100	206,00

■ Reduziermuffen, rund

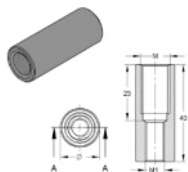

Gewinde Innen	Gewinde Außen	Artikel-Nr.	VPE [St]	PE [St]	Euro/PE
M8	M10	0710016	100	100	73,00
M8	M12	0710024	100	100	73,00
M10	M12	0710032	100	100	73,00
M12	M16	0710105	25	100	118,00

■ Reduzierstücke, sechskant

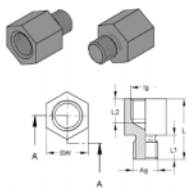

Gewinde Innen	Gewinde Außen	Artikel-Nr.	VPE [St]	PE [St]	Euro/PE
M8	M10	0725528	100	100	80,00
M10	M8	0720518	100	100	80,00
M10	M12	0720496	100	100	80,00
M12	M10	0720011	100	100	95,00
M16	M12	0726508	50	100	245,00

■ Doppelnippel, DIN 2982



Gewinde [Zoll]	Länge [mm]	Artikel-Nr.	VPE [St]	PE [St]	Euro/PE
1/2"	40	0700403	1	1	1,00
1/2"	60	0700603	1	1	1,05
1/2"	80	0700803	1	1	1,15
1/2"	100	0701003	1	1	1,35
1/2"	120	0701203	1	1	1,55
1/2"	150	0701503	1	1	1,75

■ Überwurfmuffe

Für Rohrschelle Trabant und Omnia MB (bis 125 mm)

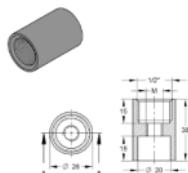

Gewinde	Gewinde	Artikel-Nr.	VPE [St]	PE [St]	Euro/PE
M8 auf	Muffe 1/2"	0590304	50	100	200,00
M10 auf	Muffe 1/2"	0590401	50	100	200,00

■ Zylinderschrauben mit Schlitz, DIN 84, mit Mutter DIN 934

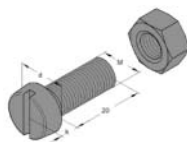

Gewinde	Länge [mm]	Artikel-Nr.	VPE [St]	PE [St]	Euro/PE
M6	20	3220060	100	100	10,50
M8	20	3220095	100	100	26,25

■ Distanzrohr

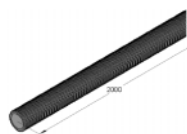

Gewinde	Länge [mm]	Artikel-Nr.	VPE [m]	PE [m]	Euro/PE
1/2"	2.000	0737002	2	1	9,20
3/4"	2.000	0737003	2	1	13,90
1"	2.000	0737004	2	1	17,00
1 1/4"	2.000	0737005	2	1	41,00

■ Zylinderschraube mit Innensechskant und Holzgewinde

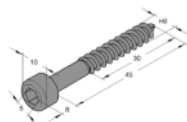

Gewinde	Länge [mm]	Artikel-Nr.	VPE [St]	PE [St]	Euro/PE
H 6	45	3442450	100	100	22,00

■ Zylinderschraube mit Innensechskant, DIN 912

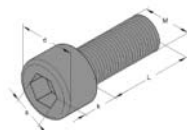

Gewinde	Länge [mm]	Artikel-Nr.	VPE [St]	PE [St]	Euro/PE
M8	16	3443167	100	100	14,50
M8	20	3443205	100	100	14,50
M10	20	3444200	100	100	27,50
M10	25	3444252	100	100	27,50
M12	25	3445259	100	100	40,00

■ Sechskantschrauben DIN 933

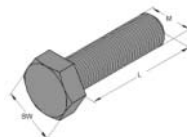

Gewinde	Schlüsselweite	Länge [mm]	Artikel-Nr.	VPE [St]	PE [St]	Euro/PE
M8	SW 13	16	3204165	100	100	8,75
		20	3204205	100	100	8,75
		25	3204255	100	100	9,90
		30	3204305	100	100	10,95
		35	3204355	100	100	12,05
		40	3204405	100	100	15,35
		45	3204455	100	100	17,50
		50	3204503	100	100	27,30

Gewinde	Schlüsselweite	Länge [mm]	Artikel-Nr.	VPE [St]	PE [St]	Euro/PE
M10	SW 17	16	3205162	100	100	15,35
		20	3205201	100	100	15,35
		25	3205251	100	100	15,35
		30	3205301	100	100	20,80
		35	3205302	100	100	21,85
		40	3205401	100	100	26,25
		45	3206508	100	100	28,45
		50	3205501	100	100	30,60
M12	SW 19	20	3206205	100	100	28,45
		25	3206591	100	100	21,85
		30	3206305	100	100	29,55
		35	3206306	100	100	31,70
		40	3206606	100	100	33,90
		45	32066064	100	100	40,45
		50	32066065	100	100	42,65
		60	32066066	100	100	49,15

Seite 5/12 Artikelgruppe 5

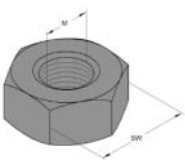

Sechskantmuttern DIN 934

Gewinde	Artikel-Nr.	VPE [St]	PE [St]	Euro/PE
M6	4120442	100	100	2,90
M8	4120450	100	100	3,50
M10	4120477	100	100	6,90
M12	4120485	100	100	11,40
M16	4120523	100	100	19,95

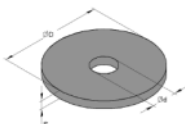

Unterlegscheiben

Abmessungen [mm]	Artikel-Nr.	VPE [St]	PE [St]	Euro/PE
DIN 125				
6,4 x 12,0 x 1,6	4320247	100	100	1,20
8,4 x 16,0 x 1,6	4320255	100	100	2,20
10,5 x 20,0 x 2,0	4320263	100	100	3,80
13,0 x 24,0 x 2,5	4320271	100	100	6,30
DIN 9021, mit größerer Auflagefläche				
5,3 x 15,0 x 1,6	4330226	100	100	2,00
6,4 x 18,0 x 1,6	4330242	100	100	2,35
8,4 x 25,0 x 2,0	4330250	100	100	4,00
10,5 x 30,0 x 2,5	4330269	100	100	7,75
13,0 x 37,0 x 3,0	4330277	100	100	15,15
17,0 x 50,0 x 3,0	4330285	100	100	23,95
verstärkt, mit größerer Auflagefläche				
8,4 x 35,0 x 3,0	4350847	100	100	12,80
10,5 x 35,0 x 3,0	4351053	100	100	12,80
13,0 x 30,0 x 2,5	4351282	100	100	10,30
8,4 x 44,0 x 3,5	4350850	100	100	14,50
10,5 x 44,0 x 3,5	4351059	100	100	14,50
13,5 x 44,0 x 4,0	4351344	100	100	16,70
17,0 x 44,0 x 3,5	4351744	100	100	23,95

Seite 5/13 Artikelgruppe 5

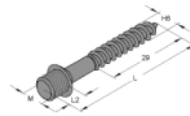

Ansatzschrauben

Gewinde	Länge [mm]	Artikel-Nr.	VPE [St]	PE [St]	Euro/PE
M6	50	3616053	100	100	14,25
M6	80	3616088	100	100	15,60
M8	50	3618056	100	100	15,60
M8	80	3618080	100	100	18,00
M8	120	3618129	100	100	28,00

für Stufengewinde

M8	50	3619050	100	100	15,60
M8	80	3619080	100	100	18,00
M8	120	3619120	100	100	28,00

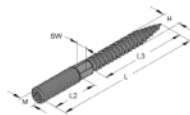

Stockschrauben, Vielzahn TX 25

Gewinde	Länge [mm]	Artikel-Nr.	VPE [St]	PE [St]	Euro/PE
M6	60*	3600025	100	100	11,10
M8	50	3600032	100	100	11,85
M8	60	3600033	100	100	12,25
M8	80	3600041	100	100	13,65
M8	100	3600068	100	100	20,00
M8	120	3608123	100	100	24,00
M8	140	3608131	100	100	26,00
M8	160	3608166	100	100	30,00
M10	50*	3609055	100	100	20,30
M10	60	3609063	100	100	20,30
M10	80	3609081	100	100	20,90
M10	100	3609103	50	100	25,30
M10	120	3609138	50	100	29,00
M10	140	3609146	50	100	31,90
M10	180	3609189	50	100	54,00
M12	100*	3609510	50	100	46,40

* Ausführung ohne Vielzahn TX 25

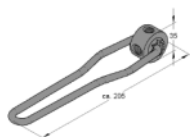

Vierfachschlüssel

Bezeichnung	Artikel-Nr.	VPE [St]	PE [St]	Euro/PE
Nettopreis				
für M6, M8, M10, M12				
Vierfachschlüssel	5200016	1	1	13,00

Seite 5/13

Artikelgruppe 5

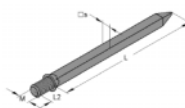

■ Schlagstifte mit Bund

Gewinde	Länge [mm]	Artikel-Nr.	VPE [St]	PE [St]	Euro/PE
M8	100	3623009	50	100	29,50
M8	150	3623505	50	100	46,50
M10	100	3625001	50	100	40,85
M10	150	3625508	50	100	59,00

Seite 5/14

Artikelgruppe 5

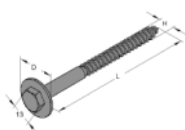

■ Laschenschrauben

Gewinde	Länge [mm]	Artikel-Nr.	VPE [St]	PE [St]	Euro/PE
H8	50	3500012	100	100	28,95
H8	60	3500020	100	100	30,10
H8	70	3500039	100	100	33,40
H8	80	3500047	100	100	34,55
H8	90	3500055	100	100	40,10
H8	100	3500063	100	100	43,45
H10	50	3500071	25	100	45,50
H10	60	3500098	25	100	47,65
H10	70	3500101	25	100	53,05
H10	80	3500128	25	100	54,10
H10	90	3500136	25	100	60,60
H10	100	3500144	25	100	62,75
H10	110	3500152	25	100	73,60
H10	120	3500160	25	100	74,70

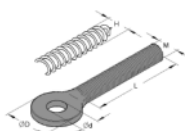

■ Ösenschrauben

Gewinde	Länge [mm]	Artikel-Nr.	VPE [St]	PE [St]	Euro/PE
Mit Holzgewinde					
H6	32	1180010	100	100	27,30
Mit metrischem Gewinde					
M6	40	1190016	100	100	21,85
M8	20	1190059	100	100	31,70
M8	45	1190024	100	100	31,70
M10	20	1190040	100	100	40,45
M10	45	1190032	100	100	45,90

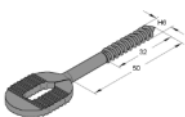

■ Langlochschraube

Gewinde	Länge [mm]	Artikel-Nr.	VPE [St]	PE [St]	Euro/PE
H6	32	1140019	100	100	21,85

Seite 5/15

Artikelgruppe 5

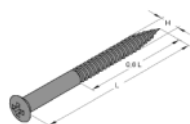

■ Messing-Holzschrauben
DIN 7995, verchromt

Gewinde	Länge [mm]	Artikel-Nr.	VPE [St]	PE [St]	Euro/PE
4,0	30	3250356	200	100	12,35
4,0	35	3250364	200	100	13,80
4,0	40	3250372	200	100	14,70
4,0	45	3250380	200	100	17,75
4,0	50	3250399	200	100	20,20
4,0	60	3250402	200	100	34,95
4,5	40	3250453	200	100	18,70
4,5	45	3250461	200	100	21,15
4,5	50	3250488	200	100	23,55
4,5	60	3250490	200	100	37,20
5,0	40	3250569	200	100	24,50
5,0	45	3250577	200	100	25,95
5,0	50	3250585	200	100	28,10
5,0	60	3250593	200	100	34,25
5,0	80	3250615	200	100	47,85
6,0	40	3258632	200	100	40,50
6,0	50	3258667	200	100	43,35
6,0	60	3258675	100	100	48,80
6,0	70	3258683	100	100	63,20
6,0	80	3258691	100	100	73,75

Seite 5/16

Artikelgruppe 5

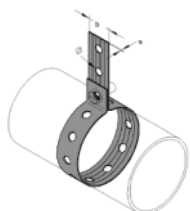

■ Montagebänder

Bezeichnung	Stahlband [mm]	Artikel-Nr.	VPE [m]	PE [m]	Euro/PE
Plastahl, kunststoffummantelt					
19	17 x 0,8	1100017	150	1	0,93
27	25 x 1,0	1100025	100	1	2,05
Lochband, sendzimir-verzinkt					
17	17 x 0,8	1110012	200	1	0,62
25	25 x 1,0	1110020	100	1	1,05
25	25 x 1,5	1110039	100	1	1,30

Seite 5/16 Artikelgruppe 5

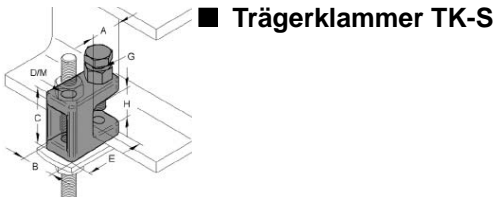

■ Trägerklammer TK-S

Bezeichnung	Durchgangsloch / Gewinde	Artikel-Nr.	VPE [St]	PE [St]	Euro/PE
mit Durchgangsloch					
TK-S B1	Ø 9 mm	0579451	50	1	3,40
TK-S B2	Ø 11 mm	0579452	50	1	3,60
TK-S B3	Ø 13 mm	0579453	50	1	4,05
TK-S B4	Ø 17 mm	0579448	25	1	5,90

Bezeichnung	Gewinde	Artikel-Nr.	VPE [St]	PE [St]	Euro/PE
mit Gewinde					
TK-S G1	M8	0579551	50	1	3,40
TK-S G2	M10	0579552	50	1	3,60
TK-S G3	M12	0579553	50	1	4,05
TK-S G4	M16	0579548	50	1	5,90

Seite 5/17 Artikelgruppe 5

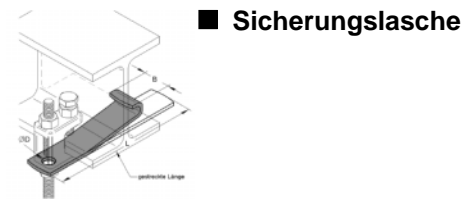

■ Sicherungsglasche

Bezeichnung	Für Rohr-Ø	Artikel-Nr.	VPE [St]	PE [St]	Euro/PE
S 3	3"- 4"	0579303	50	1	2,00
S 5	5"- 6"	0579305	50	1	2,25
S 8	8"	0579308	50	1	2,25

Seite 5/17 Artikelgruppe 5



■ Trägerklammer F3, zweiteilig

Lieferzeit: Auf Anfrage.

Bezeichnung / Gewinde	Artikel-Nr.	VPE [St]	PE [St]	Euro/PE
F3/M8	0579613	1	1	11,20
F3/M10	0579625	1	1	16,05
F3/M12	0579637	1	1	27,45
F3/M16	0579649	1	1	49,30

Seite 5/17 Artikelgruppe 5

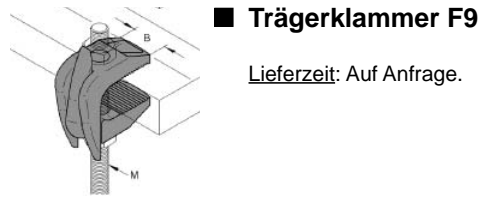

■ Trägerklammer F9

Lieferzeit: Auf Anfrage.

Bezeichnung / Gewinde	Artikel-Nr.	VPE [St]	PE [St]	Euro/PE
F9/M10	0579702	1	1	31,60
F9/M12	0579703	1	1	62,00
F9/M16	0579704	1	1	100,00
F9/M20	0579705	1	1	125,70

Seite 6/5 Artikelgruppe 6



■ Polar Kälteschelle PE/PU >145< mit Schweißmutter

Lieferzeit: 3 Arbeitstage, ab Werk Kupferzell

Rohr-Ø [mm]	Cu [mm]	SMU	Artikel-Nr.	VPE [St]	PE [St]	Euro/PE
Isolierstärke 20 mm, PU-Schale 20 x 35 mm						
15,0		M8	74601554/SW2	5	1	10,45
17,2	18	M8	74601854/SW2	5	1	10,45
21,3	22	M8	74602354/SW2	5	1	10,60
26,9	28	M8/10	74602848/SW2	5	1	11,95

Rohr-Ø [mm]	Cu [mm]	SMU	Artikel-Nr.	VPE [St]	PE [St]	Euro/PE
Isolierstärke 20 mm, PU-Schale 20 x 40 mm						
33,7	35	M8/10	74603348/SW2	1	1	13,35
42,4	42	M8/10	74604348/SW2	1	1	15,00
48,3		M8/10	74604949/SW2	1	1	16,70
57,0		M8/10	74605849/SW2	1	1	19,45
60,3		M8/10	74606149/SW2	1	1	19,65
63,5		M8/10	74606549/SW2	1	1	20,90
70,0		M8/10	74607149/SW2	1	1	21,45
76,1		M8/10	74607749/SW2	1	1	20,50

Rohr-Ø [mm]	Cu [mm]	SMU	Artikel-Nr.	VPE [St]	PE [St]	Euro/PE
Isolierstärke 20 mm, PU-Schale 20 x 50 mm						
88,9		M10/12	74608942/SW2	1	1	28,00
108,0		M10/12	74610844/SW2	1	1	32,60
114,3		M10/12	74611444/SW2	1	1	33,35

Rohr-Ø [mm]	Cu [mm]	SMU	Artikel-Nr.	VPE [St]	PE [St]	Euro/PE
Isolierstärke 30 mm, PU-Schale 30 x 40 mm						
42,4		M8/10	74704349/SW2	1	1	16,75
48,3		M8/10	74704949/SW2	1	1	17,20

Rohr-Ø [mm]	Cu [mm]	SMU	Artikel-Nr.	VPE [St]	PE [St]	Euro/PE
Isolierstärke 30 mm, PU-Schale 30 x 50 mm						
57,0		M10/12	74705842/SW2	1	1	22,35
60,3		M10/12	74706142/SW2	1	1	24,05
63,5		M10/12	74706542/SW2	1	1	24,05
70,0		M10/12	74707144/SW2	1	1	26,40
76,1		M10/12	74707744/SW2	1	1	27,35
88,9		M10/12	74709044/SW2	1	1	29,95

Fortsetzung →



■ Polar Kälteschelle PE/PU >145< mit Schweißmutter

Rohr- Ø [mm]	Cu [mm]	SMU	Artikel-Nr.	VPE [St]	PE [St]	Euro/PE
--------------------	------------	-----	-------------	-------------	------------	---------

Isolierstärke 30 mm, PU-Schale 30 x 60 mm

108,0		M10/12	74710844/SW2	1	1	36,10
114,3		M10/12	74711444/SW2	1	1	36,30
133,0		M10/12	74713344/SW2	1	1	40,05
139,7		M10/12	74714044/SW2	1	1	41,25
159,0		M10/12	74715944/SW2	1	1	44,55
168,3		M10/12	74716844/SW2	1	1	52,60
219,1		M16	74721927/SW2	1	1	70,10

Isolierstärke 40 mm, PU-Schale 40 x 60 mm

108,0		M10/12	74810944/SW2	1	1	38,90
114,3		M10/12	74811544/SW2	1	1	40,85
133,0		M10/12	74813444/SW2	1	1	43,60
139,7		M10/12	74814144/SW2	1	1	44,70
159,0		M10/12	74816044/SW2	1	1	46,95
168,3		M10/12	74816944/SW2	1	1	53,65
219,1		M16	74822019/SW2	1	1	77,00
273,0		M16	74827319/SW2	1	1	140,00

Isolierstärke 40 mm, PU-Schale 40 x 80 mm

323,9		M16	74832519/SW2	1	1	170,00
-------	--	-----	--------------	---	---	--------

Isolierstärke 40 mm, PU-Schale 40 x 90 mm

355,6		M16	74835619/SW2	1	1	220,00
-------	--	-----	--------------	---	---	--------

Isolierstärke 40 mm, PU-Schale 40 x 100 mm

406,4		M16	74840619/SW2	1	1	260,00
-------	--	-----	--------------	---	---	--------

Rohr- Ø [mm]	Cu [mm]	SMU	Artikel-Nr.	VPE [St]	PE [St]	Euro/PE
--------------------	------------	-----	-------------	-------------	------------	---------

Isolierstärke 13 mm, PU-Schale 13 x 50 mm

42,4		M8/10	68304249	1	1	10,00
48,3		M8/10	68304849	1	1	10,90
54,0		M8/10	68305449	1	1	11,40
57,0		M8/10	68305749	1	1	11,70
60,3		M8/10	68306048	1	1	12,60
63,5		M8/10	68306449	1	1	12,80
70,0		M8/10	68307049	1	1	15,10
76,1		M8/10	68307649	1	1	15,20
88,9		M8/10	68308949	1	1	15,30
108,0		M10/12	68310850	1	1	23,10

Isolierstärke 13 mm, PU-Schale 13 x 100 mm

114,3		M10/12	68311450	1	1	25,30
133,0		M10/12	68313350	1	1	32,00
139,7		M10/12	68314050	1	1	33,00
159,0		M10/12	68315944	1	1	39,00
168,3		M10/12	68316844	1	1	44,85

Isolierstärke 19 mm, PU-Schale 19 x 50 mm

15,0		M8	68401554	1	1	9,20
17,2	18	M8	68401854	1	1	9,40
21,3	22	M8/10	68402248	1	1	9,90
26,9	28	M8/10	68402849	1	1	10,30
33,7	35	M8/10	68403548	1	1	10,90
42,4		M8/10	68404249	1	1	12,50
48,3		M8/10	68404849	1	1	13,50
54,0		M8/10	68405449	1	1	15,00
57,0		M8/10	68405749	1	1	15,00
60,3		M8/10	68406049	1	1	15,75
63,5		M8/10	68406449	1	1	15,95
70,0		M8/10	68407049	1	1	20,20
76,1		M8/10	68407649	1	1	20,20
88,9		M10/12	68408950	1	1	22,65
108,0		M10/12	68410850	1	1	27,65

Isolierstärke 19 mm, PU-Schale 19 x 100 mm

114,3		M10/12	68411450	1	1	31,05
133,0		M10/12	68413350	1	1	38,75
139,7		M10/12	68414044	1	1	41,20
159,0		M10/12	68415944	1	1	44,85
168,3		M10/12	68416844	1	1	55,05
219,1		M16	68421927	1	1	79,50



■ Husky Kälteschelle Kautschuk/PU >120< mit Schweißmutter

Lieferzeit: 3 Arbeitstage,
ab Werk Kupferzell

Rohr- Ø [mm]	Cu [mm]	SMU	Artikel-Nr.	VPE [St]	PE [St]	Euro/PE
--------------------	------------	-----	-------------	-------------	------------	---------

Isolierstärke 13 mm, PU-Schale 13 x 50 mm

12,0		M8	68301254	1	1	7,90
15,0		M8	68301554	1	1	7,90
17,2	18	M8	68301854	1	1	7,90
21,3	22	M8	68302254	1	1	8,10
26,9	28	M8	68302854	1	1	8,75
33,7	35	M8/10	68303548	1	1	9,50



■ Kälteschelle ALU/PU >80< mit Schweißmutter

Lieferzeit: 5 Arbeitstage,
ab Werk Kupferzell



■ Kälteschelle ALU/PU >80< mit Schweißmutter, mit Blechzylinder

Rohr-Ø	[mm]	Artikel-Nr.	VPE	PE	Euro/PE	Artikel-Nr.	VPE	PE	Euro/PE	
Stahl	CU	ohne Blechzy.	[St]	[St]		mit Blechzy.	[St]	[St]		
Isolierstärke 20 mm, Schalenlänge 100 mm										
15,0		M8/10	75601545	1	1	5,57	75601545/B	1	1	9,32
17,2	18,0	M8/10	7560172	1	1	5,57	75601745/B	1	1	9,32
21,3	22,0	M8/10	75602145	1	1	5,81	75602145/B	1	1	9,56
26,9	28,0	M8/10	7560275	1	1	5,99	75602745/B	1	1	9,79
33,7	35,0	M8/10	75603445	1	1	7,30	75603445/B	1	1	11,15
42,4	42,0	M10/12	7560426	1	1	8,29	7560426/B	1	1	12,19
48,3		M10/12	7560486	1	1	8,60	7560486/B	1	1	12,50
54,0		M10/12	75605432	1	1	9,47	7560543/B	1	1	13,47
57,0		M10/12	75605742	1	1	9,71	75605742/B	1	1	13,71
60,3		M10/12	7560606	1	1	9,93	7560606/B	1	1	13,93
63,5		M10/12	75606442	1	1	10,20	75606442/B	1	1	14,25
70,0		M10/12	75607042	1	1	12,73	75607042/B	1	1	16,88
76,1		M10/12	7560766	1	1	11,27	75607642/B	1	1	15,42
88,9		M10/12	7560896	1	1	13,07	7560896/B	1	1	17,27
108,0		M10/12	75610844	1	1	15,21	75610844/B	1	1	19,46
114,3		M10/12	75611444	1	1	16,11	75611444/B	1	1	20,46
133,0		M10/12	75613344	1	1	17,77	75613344/B	1	1	22,47
139,7		M10/12	75614044	1	1	19,00	75614044/B	1	1	23,70
159,0		M10/12	75615944	1	1	21,12	75615944/B	1	1	26,37
168,3		M10/12	75616844	1	1	22,13	75616844/B	1	1	27,48
219,1		M16	7562197	1	1	43,83	7562197/B	1	1	50,48
273,0		M16	7562733	1	1	48,28	7562733/B	1	1	55,33

Isolierstärke 30 mm, Schalenlänge 100 mm

17,2	18,0	M10/12	7590182	1	1	7,91	7590182/B	1	1	11,76
21,3	22,0	M10/12	75902142	1	1	8,21	75902142/B	1	1	12,11
26,9	28,0	M10/12	75902742	1	1	8,51	75902742/B	1	1	12,41
33,7		M10/12	75903442	1	1	9,29	75903442/B	1	1	13,29
42,4		M10/12	75904242	1	1	10,03	75904242/B	1	1	14,03
48,3		M10/12	75904842	1	1	10,43	75904842/B	1	1	14,53
54,0		M10/12	75905442	1	1	11,17	75905442/B	1	1	15,32
57,0		M10/12	75905742	1	1	11,17	75905742/B	1	1	15,32
60,3		M10/12	75906042	1	1	11,54	75906042/B	1	1	15,69
63,5		M10/12	75906442	1	1	11,80	75906442/B	1	1	16,00
70,0		M10/12	75907042	1	1	16,57	75907042/B	1	1	20,77
76,1		M10/12	75907644	1	1	14,27	75907644/B	1	1	18,47
88,9		M10/12	75908944	1	1	15,51	75908944/B	1	1	19,81
108,0		M10/12	75910844	1	1	17,93	75910844/B	1	1	22,38
114,3		M10/12	75911444	1	1	18,16	75911444/B	1	1	22,86
133,0		M10/12	75913344	1	1	20,71	75913344/B	1	1	25,86
139,7		M10/12	75914044	1	1	21,47	75914044/B	1	1	26,77
159,0		M10/12	75915912	1	1	23,73	75915944/B	1	1	29,13
168,3		M10/12	75916844	1	1	25,13	75916844/B	1	1	30,53
219,1		M16	7592193	1	1	48,31	7592193/B	1	1	55,11
273,0		M16	7592733	1	1	51,87	7592733/B	1	1	60,12
323,9		M16	7593243	1	1	61,48	7593243/B	1	1	70,13
355,6		M16	7593563	1	1	67,89	7593563/B	1	1	81,19

Aufpreis für Anschlußgewinde 45° versetzt

1 1,10



■ Kälteschelle ALU/PU >80< mit Schweißmutter

Lieferzeit: 5 Arbeitstage,
ab Werk Kupferzell



■ Kälteschelle ALU/PU >80< mit Schweißmutter, mit Blechzylinder

Rohr-Ø Stahl	[mm] CU	Artikel-Nr. ohne Blechzy.	VPE [St]	PE [St]	Euro/PE	Artikel-Nr. mit Blechzy.	VPE [St]	PE [St]	Euro/PE
Isolierstärke 40 mm, Schalenlänge 100 mm									
17,2	M10/12	76201742	1	1	9,49	76201742/B	1	1	13,49
21,3	M10/12	76202142	1	1	9,69	76202142/B	1	1	13,69
26,9	M10/12	76202742	1	1	10,33	76202742/B	1	1	14,38
33,7	M10/12	7620348	1	1	10,87	76203442/B	1	1	15,02
42,4	M10/12	7620428	1	1	11,54	7620428/B	1	1	15,69
48,3	M10/12	7620488	1	1	12,10	76204842/B	1	1	16,30
54,0	M10/12	7620548	1	1	17,27	76205444/B	1	1	21,47
57,0	M10/12	76205744	1	1	14,56	76205744/B	1	1	18,76
60,3	M10/12	76206044	1	1	15,06	7620608/B	1	1	19,31
63,5	M10/12	76206444	1	1	15,26	76206444/B	1	1	19,51
70,0	M10/12	7620708	1	1	19,91	76207044/B	1	1	24,21
76,1	M10/12	76207644	1	1	17,18	7620768/B	1	1	21,53
88,9	M10/12	7620898	1	1	18,23	76208944/B	1	1	22,68
108,0	M10/12	76210844	1	1	20,43	76210844/B	1	1	25,23
114,3	M10/12	7621148	1	1	21,11	76211444/B	1	1	26,36
133,0	M10/12	76213344	1	1	23,57	76213344/B	1	1	28,97
139,7	M10/12	7621408	1	1	24,33	7621408/B	1	1	29,73
159,0	M10/12	76215944	1	1	26,72	76215944/B	1	1	32,22
168,3	M10/12	7621688	1	1	28,09	7621688/B	1	1	34,64
219,1	M16	7622196	1	1	48,36	7622196/B	1	1	55,31
273,0	M16	7622736	1	1	57,10	7622736/B	1	1	65,50
323,9	M16	7623247	1	1	66,49	7623247/B	1	1	79,69
355,6	M16	7623565	1	1	77,08	7623565/B	1	1	90,53

Isolierstärke 50 mm, Schalenlänge 100 mm

17,2	M10/12	76501742	1	1	11,04	76501742/B	1	1	15,19
21,3	M10/12	76502142	1	1	11,44	76502142/B	1	1	15,59
26,9	M10/12	76502742	1	1	11,80	76502742/B	1	1	16,00
33,7	M10/12	76503444	1	1	13,87	76503444/B	1	1	18,07
42,4	M10/12	76504244	1	1	15,06	76504244/B	1	1	19,31
48,3	M10/12	76504844	1	1	16,01	76504844/B	1	1	20,26
54,0	M10/12	76505444	1	1	20,41	76505444/B	1	1	24,76
57,0	M10/12	76505744	1	1	16,98	76505744/B	1	1	21,33
60,3	M10/12	76506044	1	1	16,80	76506044/B	1	1	21,15
63,5	M10/12	76506444	1	1	18,35	76506444/B	1	1	22,80
70,0	M10/12	76507044	1	1	23,13	76507044/B	1	1	27,58
76,1	M10/12	76507644	1	1	19,46	76507644/B	1	1	24,16
88,9	M10/12	76508944	1	1	20,63	76508944/B	1	1	25,43
108,0	M10/12	76510844	1	1	23,37	76510844/B	1	1	28,72
114,3	M10/12	7651146	1	1	23,97	76511444/B	1	1	29,37
133,0	M10/12	76513344	1	1	26,23	76513344/B	1	1	31,63
139,7	M10/12	76514044	1	1	27,02	76514044/B	1	1	32,52
159,0	M10/12	76515944	1	1	29,65	76515944/B	1	1	36,30
168,3	M10/12	76516844	1	1	31,02	76516844/B	1	1	37,72
219,1	M16	7652195	1	1	57,19	7652195/B	1	1	65,34
273,0	M16	7652734	1	1	61,36	7652734/B	1	1	69,91
323,9	M16	7653245	1	1	70,18	7653245/B	1	1	83,53
355,6	M16	7653567	1	1	82,77	7653567/B	1	1	96,37

Aufpreis für Muffen von M10 oder M12 auf...

1/2" Muffe	1	0,88
3/4" Muffe	1	1,23
1" Muffe	1	1,93

Aufpreis für Muffen von M16 auf...

1/2" Muffe	1	0,40
3/4" Muffe	1	0,65
1" Muffe	1	1,45



■ **Kälteschelle ALU/PU >80< S
mit Schweißmutter**

Lieferzeit: 5 Arbeitstage,
ab Werk Kupferzell



■ **Kälteschelle ALU/PU >80< S
mit Schweißmutter,
mit Tragschale**

Rohr-Ø Stahl	Schalen- länge	Anschluß- gewinde	Artikel-Nr. ohne Tragsch.	VPE [St]	PE [St]	Euro/PE	Artikel-Nr. Tragschale	VPE [St]	PE [St]	Euro/PE
Isolierstärke 20 mm,										
17,2	40	M8/10	70401848	1	1	4,69	-	1	1	-
21,3	40	M8/10	70402248	1	1	4,93	-	1	1	-
26,9	40	M8/10	70402848	1	1	5,02	-	1	1	-
33,7	40	M8/10	70403448	1	1	5,43	-	1	1	-
42,4	40	M8/10	70404248	1	1	5,72	-	1	1	-
48,3	50	M8/10	70504849	1	1	6,73	-	1	1	-
57,0	50	M8/10	70505748	1	1	7,64	-	1	1	-
60,3	50	M8/10	70506049	1	1	7,74	-	1	1	-
63,5	50	M8/10	70506449	1	1	8,32	-	1	1	-
70,0	83	M8/10	70607049	1	1	9,75	70607049/T	1	1	11,49
76,1	83	M8/10	70607649	1	1	9,30	70607649/T	1	1	11,04
88,9	83	M8/10	75208949	1	1	10,54	75208949/T	1	1	12,40
108,0	83	M10/12	75210850	1	1	12,44	75210850/T	1	1	14,56
114,3	83	M10/12	75211442	1	1	13,79	75211442/T	1	1	15,92
133,0	100	M10/12	75613350	1	1	13,86	75613350/T	1	1	16,04
139,7	100	M10/12	75614042	1	1	17,33	75614042/T	1	1	19,54
159,0	100	M10/12	75615942	1	1	19,83	75615942/T	1	1	22,29
168,3	100	M10/12	75616842	1	1	20,64	75616842/T	1	1	23,12
219,1	100	M16	75621927	1	1	28,55	75621927/T	1	1	31,60

Isolierstärke 30 mm

17,2	40	M8/10	71101848	1	1	5,50	-	1	1	-
21,3	40	M8/10	71102248	1	1	5,57	-	1	1	-
26,9	40	M8/10	71102849	1	1	6,22	-	1	1	-
33,7	40	M8/10	71103448	1	1	6,35	-	1	1	-
42,4	40	M8/10	71104249	1	1	7,11	-	1	1	-
48,3	50	M8/10	71204849	1	1	8,38	-	1	1	-
57,0	50	M8/10	71205749	1	1	8,88	-	1	1	-
60,3	50	M8/10	71206049	1	1	9,23	-	1	1	-
63,5	50	M8/10	71206449	1	1	9,53	-	1	1	-
70,0	66	M8/10	71307049	1	1	11,13	71307049/T	1	1	12,90
76,1	66	M8/10	71307649	1	1	10,41	71307649/T	1	1	12,19
88,9	83	M10/12	75308950	1	1	12,67	75308950/T	1	1	14,79
108,0	83	M10/12	75310850	1	1	14,29	75310850/T	1	1	16,46
114,3	83	M10/12	75311450	1	1	14,74	75311450/T	1	1	16,92
133,0	100	M10/12	75913342	1	1	19,42	75913342/T	1	1	21,87
139,7	100	M10/12	75914042	1	1	20,23	75914042/T	1	1	22,69
159,0	100	M10/12	75915942	1	1	22,29	75915942/T	1	1	24,80
168,3	100	M10/12	75916844	1	1	24,13	75916844/T	1	1	26,67
219,1	100	M16	75921927	1	1	30,02	75921927/T	1	1	33,12



■ **Kälteschelle ALU/PU >80< S mit Schweißmutter**

Lieferzeit: 5 Arbeitstage,
ab Werk Kupferzell

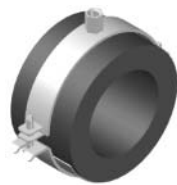

■ **Kälteschelle ALU/PU >80< S mit Schweißmutter, mit Tragschale**

Rohr-Ø Stahl	Schalen- länge	Anschluß- gewinde	Artikel-Nr. ohne Tragsch.	VPE [St]	PE [St]	Euro/PE	Artikel-Nr. Tragschale	VPE [St]	PE [St]	Euro/PE
Isolierstärke 40 mm,										
17,2	40	M8/10	71401848	1	1	6,65	-	1	1	-
21,3	40	M8/10	71402249	1	1	7,01	-	1	1	-
26,9	40	M8/10	71402849	1	1	7,68	-	1	1	-
33,7	40	M8/10	71403449	1	1	8,08	-	1	1	-
42,4	40	M8/10	71404249	1	1	8,43	-	1	1	-
48,3	50	M8/10	71504849	1	1	10,13	-	1	1	-
57,0	50	M8/10	71505749	1	1	10,51	-	1	1	-
60,3	50	M10/12	71506042	1	1	10,99	-	1	1	-
63,5	50	M10/12	71506450	1	1	11,20	-	1	1	-
70,0	66	M10/12	71607050	1	1	12,60	71607050/T	1	1	14,63
76,1	66	M10/12	71607642	1	1	13,52	71607642/T	1	1	15,56
88,9	83	M10/12	75408950	1	1	14,95	75408950/T	1	1	17,13
108,0	83	M10/12	75410842	1	1	18,16	75410842/T	1	1	20,38
114,3	83	M10/12	75411442	1	1	19,42	75411442/T	1	1	21,87
133,0	100	M10/12	76213344	1	1	22,08	76213344/T	1	1	24,58
139,7	100	M10/12	7621408	1	1	22,89	7621408/T	1	1	25,40
159,0	100	M10/12	76215944	1	1	26,72	76215944/T	1	1	29,71
168,3	100	M10/12	7621688	1	1	28,09	7621688/T	1	1	31,10
219,1	100	M16	7622195	1	1	33,89	7622195/T	1	1	37,83

Isolierstärke 50 mm

17,2	40	M8/10	71701849	1	1	7,53	-	1	1	-
21,3	40	M8/10	71702249	1	1	7,63	-	1	1	-
26,9	40	M8/10	71702849	1	1	7,83	-	1	1	-
33,7	40	M8/10	71703449	1	1	8,21	-	1	1	-
42,4	40	M10/12	71704250	1	1	10,82	-	1	1	-
48,3	50	M10/12	71804850	1	1	11,87	-	1	1	-
57,0	50	M10/12	71805742	1	1	15,27	-	1	1	-
60,3	50	M10/12	71806042	1	1	16,03	-	1	1	-
63,5	50	M10/12	71806442	1	1	16,47	-	1	1	-
70,0	66	M10/12	71907050	1	1	17,29	71907050/T	1	1	19,36
76,1	66	M10/12	71907650	1	1	17,34	71907650/T	1	1	19,42
88,9	83	M10/12	75508942	1	1	20,98	75508942/T	1	1	23,41
108,0	83	M10/12	75510842	1	1	20,78	75510842/T	1	1	23,26
114,3	83	M10/12	75511442	1	1	21,28	75511442/T	1	1	23,78
133,0	100	M10/12	76513344	1	1	26,23	76513344/T	1	1	28,78
139,7	100	M10/12	76514044	1	1	27,02	76514044/T	1	1	30,01
159,0	100	M10/12	76515944	1	1	29,65	76515944/T	1	1	32,69
168,3	100	M10/12	76516844	1	1	31,02	76516844/T	1	1	34,09
219,1	100	M16	76521927	1	1	39,50	76521927/T	1	1	43,50

Seite 6/16

Artikelgruppe 6



■ **Blechzylinder 80 mm**
als Tragschale für ALU/PU-Isolierung

Rohr-Ø [mm]	Artikel-Nr.	VPE [St]	PE [St]	Euro/PE
Isolierstärke 20 mm				
15,0	9302001	1	1	3,75
17,2	9302107	1	1	3,75
21,3	9302203	1	1	3,75
26,9	9302409	1	1	3,80
33,7	9302603	1	1	3,85
35,0	9302603	1	1	3,85
42,4	9302808	1	1	3,90
48,3	9303006	1	1	3,90
54,0	9303200	1	1	4,00
57,0	9303308	1	1	4,00
60,3	9303405	1	1	4,00
63,5	9303596	1	1	4,05
70,0	9303804	1	1	4,15
76,1	9303901	1	1	4,15
88,9	9304304	1	1	4,20
108,0	9304908	1	1	4,25
114,3	9305106	1	1	4,35
133,0	9305696	1	1	4,70
139,7	9305904	1	1	4,70
159,0	9306501	1	1	5,25
168,3	9306803	1	1	5,35

Isolierstärke 30 mm

17,2	9302700	1	1	3,85
21,3	9302808	1	1	3,90
26,9	9303006	1	1	3,90
33,7	9303200	1	1	4,00
42,4	9303405	1	1	4,00
48,3	9303596	1	1	4,05
57,0	9303901	1	1	4,15
60,3	9304002	1	1	4,15
63,5	9304096	1	1	4,15
70,0	9304304	1	1	4,20
76,1	9304509	1	1	4,20
88,9	9304908	1	1	4,25
108,0	9305505	1	1	4,45
114,3	9305696	1	1	4,70
133,0	9306307	1	1	5,15
139,7	9306501	1	1	5,25
159,0	9307109	1	1	5,40
168,3	9307400	1	1	5,40
219,1	9309004	1	1	6,80
273,0	9310703	1	1	8,25
323,9	9312307	1	1	8,65
355,6	9313303	1	1	13,30

Seite 6/16

Artikelgruppe 6

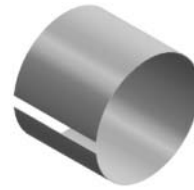

■ **Blechzylinder 80 mm**
als Tragschale für ALU/PU-Isolierung

Rohr-Ø [mm]	Artikel-Nr.	VPE [St]	PE [St]	Euro/PE
Isolierstärke 40 mm				
17,2	9303308	1	1	4,00
21,3	9303405	1	1	4,00
26,9	9303596	1	1	4,05
33,7	9303804	1	1	4,15
42,4	9304096	1	1	4,15
48,3	9304304	1	1	4,20
57,0	9304509	1	1	4,20
60,3	9304606	1	1	4,20
63,5	9304800	1	1	4,25
70,0	9304908	1	1	4,25
76,1	9305106	1	1	4,35
88,9	9305505	1	1	4,45
108,0	9306102	1	1	4,80
114,3	9306307	1	1	5,15
133,0	9306900	1	1	5,35
139,7	9307109	1	1	5,40
159,0	9307702	1	1	5,50
168,3	9308008	1	1	6,55
219,1	9309608	1	1	6,95
273,0	9311300	1	1	8,40
323,9	9312900	1	1	13,20
355,6	9313907	1	1	13,45

Isolierstärke 50 mm

17,2	9303901	1	1	4,15
21,3	9304096	1	1	4,15
26,9	9304207	1	1	4,20
33,7	9304401	1	1	4,20
42,4	9304703	1	1	4,25
48,3	9304908	1	1	4,25
57,0	9305203	1	1	4,35
60,3	9305300	1	1	4,35
63,5	9305408	1	1	4,45
70,0	9305602	1	1	4,45
76,1	9305807	1	1	4,70
88,9	9306196	1	1	4,80
108,0	9306803	1	1	5,35
114,3	9307001	1	1	5,40
133,0	9307605	1	1	5,40
139,7	9307796	1	1	5,50
159,0	9308407	1	1	6,65
168,3	9308709	1	1	6,70
219,1	9310304	1	1	8,15
273,0	9312005	1	1	8,55
323,9	9313508	1	1	13,35
355,6	9314601	1	1	13,60



■ PU-Montagekleber



Bezeichnung	Artikel-Nr.	VPE [St]	PE [St]	Euro/PE
Kartusche 0,56 kg	5911040	1	1	9,00
Eimer 5 kg	5911508	1	1	60,00



■ LB-Dübel

Abmessung [mm]	Länge [mm]	Artikel-Nr.	VPE [St]	PE [St]	Euro/PE
4	22	2030422	200	100	22,00
5	30	2030530	200	100	23,25
6	32	2030632	200	100	25,40
8	38	2030838	200	100	25,40
8	60	2030860	100	100	26,70
10	60	2031060	100	100	46,30



■ K2-Dübel

Abmessung [mm]	Länge [mm]	Artikel-Nr.	VPE [St]	PE [St]	Euro/PE
5	25	2010011	100	100	2,40
6	33	2010038	100	100	2,90
8	44	2010046	100	100	5,45
10	44	2010054	50	100	8,60
10	60	2010062	50	100	10,30
12	60	2010070	25	100	15,10
14	80	2010089	25	100	22,30

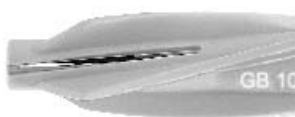

■ GB Gasbetondübel

Lieferzeit:
5 Arbeitstage ab
Werk Kupferzell

Abmessung [mm]	Länge [mm]	Artikel-Nr.	VPE [St]	PE [St]	Euro/PE
GB	8	2210055	25	100	75,00
GB	10	2210004	20	100	88,00
GB	14	2210041	10	100	158,00



■ Messing-Spreizdübel

Abmessung [mm]	Länge [mm]	Artikel-Nr.	VPE [St]	PE [St]	Euro/PE
M5	20,5	2060027	100	100	13,45
M6	22,0	2060035	100	100	14,55
M8	27,5	2060043	100	100	24,60
M10	32,0	2060051	100	100	36,80
M12	40,0	2060078	50	100	70,35
M16	44,0	2060094	50	100	154,00



■ TSM Betonschraube mit Linsenkopf

Abmessung [mm]	Artikel-Nr.	VPE [St]	PE [St]	Euro/PE
VZ 30				
5 x 60	2231560	100	100	35,00
6 x 60	2230660	100	100	41,00
6 x 80	2230680	100	100	53,00
6 x 100	2230700	100	100	58,00



■ UUE-Dübel

Abmessung [mm]	Länge [mm]	Artikel-Nr.	VPE [St]	PE [St]	Euro/PE
6	35	221079142	200	100	6,20
8	50	221079144	100	100	9,60
10	60	221079145	100	100	18,10
12	70	221079146	25	100	24,45
14	75	221079147	25	100	44,60



■ TSM Betonschraube mit Kombi-Sechskantkopf

Abmessung [mm]	SW	Artikel-Nr.	VPE [St]	PE [St]	Euro/PE
VZ 40					
8 x 80	13	2230880	50	100	102,00
8 x 100	13	2230900	50	100	114,00
8 x 140	13	2230940	50	100	140,00

Seite 7/5 Artikelgruppe 7



■ TSM Beton schraube mit Sechskantkopf

Abmessung [mm]	SW	Artikel-Nr.	VPE [St]	PE [St]	Euro/PE
6 x 60	13	2230663	100	100	41,00
10 x 90	18	2231090	50	100	176,00
10 x 110	18	2231110	50	100	194,00
10 x 140	18	2231135	50	100	212,00

Nichtrostender Stahl V4A



Lieferzeit: 5 Arbeitstage ab Werk Kupferzell

10 x 95	17	2231236	50	100	724,00
10 x 105	17	2231240	50	100	909,00
10 x 115	17	2231245	50	100	969,00

Seite 7/6 Artikelgruppe 7



■ TSM-Muffe mit Stufengewinde

Abmessung [mm]	SW	Artikel-Nr.	VPE [St]	PE [St]	Euro/PE
M8/ 10					
6 x 55	13	2230001	50	100	92,00
M 10/12					
8 x 80	17	2230009	50	100	335,00



■ TSM-Ansatzschraube

Abmessung [mm]	SW	Artikel-Nr.	VPE [St]	PE [St]	Euro/PE
6 x 55	10	2230002	100	100	59,00



■ TSM-Flachsenkopf

Abmessung [mm]	SW	Artikel-Nr.	VPE [St]	PE [St]	Euro/PE
Für Kanalhalter mit Dämmhülse, VZ 30					
5 x 40		2230540	100	100	29,00
6 x 80		2230681	100	100	53,00

Seite 7/8 Artikelgruppe 7



■ Ankerbolzen FAZ II

Abmessung [mm]	Gewinde [mm]	Artikel-Nr.	VPE [St]	PE [St]	Euro/PE
FAZ 8/10	M8	221094871	50	100	111,00
FAZ 8/30	M8	221094877	50	100	140,00
FAZ 10/10	M10	221094981	50	100	159,00
FAZ 10/30	M10	221094983	25	100	180,00
FAZ 10/50	M10	221094984	20	100	197,00
FAZ 12/10	M12	221095419	20	100	247,00
FAZ 12/30	M12	221095421	20	100	265,00
FAZ 12/50	M12	221095446	20	100	301,00
FAZ 12/100	M12	221095470	20	100	537,00
FAZ 16/100	M16	221095865	10	100	969,00

Seite 7/8 Artikelgruppe 7



■ Ankerbolzen FAZ

Abmessung [mm]	Gewinde [mm]	Artikel-Nr.	VPE [St]	PE [St]	Euro/PE
FAZ 8/10 A4	M8	222068550	50	100	333,00
FAZ 8/30 A4	M8	222068552	50	100	347,00
FAZ 10/10 A4	M10	222068555	50	100	432,00
FAZ 10/30 A4	M10	2210091	25	100	520,00
FAZ 10/50 A4	M10	222068557	20	100	620,00
FAZ 12/10 A4	M12	222068560	20	100	704,00
FAZ 12/30 A4	M12	222068561	20	100	844,00
FAZ 12/50 A4	M12	222068562	20	100	974,00
FAZ 12/100 A4	M12	222068564	20	100	1.298,00

Seite 7/9 Artikelgruppe 7



■ FZEA Zykon-Einschlaganker

Abmessung [mm]	Gewinde [mm]	Artikel-Nr.	VPE [St]	PE [St]	Euro/PE
Galvanisch verzinkt					
FZEA 10x40	M8	2171040	100	100	87,00
FZEA 12x40	M10	2171240	100	100	99,00
FZEA 14x40	M12	2171440	50	100	144,00

Nichtrostender Stahl V4A



FZEA 10x40	M8	2176040	100	100	725,00
FZEA 12x40	M10	2176240	100	100	910,00
FZEA 14x40	M12	2176440	50	100	1.565,00

Seite 7/10 Artikelgruppe 7

■ Bohr- und Setzwerkzeuge



■ Bohrer FZUB

Abmessung [mm]	passend für	Artikel-Nr.	VPE [St]	PE [St]	Euro/PE	Nettopreis
----------------	-------------	-------------	----------	---------	---------	------------

Bohrer						
FZUB 10x40	FZEA 10x40	5301040	1	1		25,30
FZUB 12x40	FZEA 12x40	5301045	1	1		26,15
FZUB 14x40	FZEA 14x40	5301050	1	1		27,50



■ Einschlaggerät FZED

Abmessung [mm]	passend für	Artikel-Nr.	VPE [St]	PE [St]	Euro/PE	Nettopreis
----------------	-------------	-------------	----------	---------	---------	------------

Einschlaggerät zur Montage mit Handhammer						
FZED 10x40	FZEA 10x40	5301080	1	1		8,70
FZED 12x40	FZEA 12x40	5301085	1	1		9,85
FZED 14x40	FZEA 14x40	5301090	1	1		12,90

Seite 7/10 Artikelgruppe 7

 ■ Einschlaggerät FZEM

Abmessung [mm]	passend für	Artikel-Nr.	VPE [St]	PE [St]	Euro/PE
Nettopreis					
Einschlaggerät zur Montage mit Bohrerhammer					
FZEM 10x40	FZEA 10x40	2210056	1	1	28,00
FZEM 12x40	FZEA 12x40	2210029	1	1	29,55
FZEM 14x40	FZEA 14x40	2210057	1	1	33,85

Seite 7/11 Artikelgruppe 7

 ■ EA-Einschlaganker

Bezeichnung	Gewinde [mm]	Artikel-Nr.	VPE [St]	PE [St]	Euro/PE
Stahl, verzinkt					
EA 6	M6	2101506	100	100	23,55
EA 8	M8	210060812	100	100	28,90
EA 10	M10	210060813	50	100	41,65
EA 12	M12	210060814	25	100	69,30
EA 16	M16	210060816	25	100	154,00
Nichtrostender Stahl V4A 					
EA 8	M8	2100031	100	100	269,00
EA 10	M10	2100039	50	100	403,00
EA 12	M12	2100049	50	100	602,00
EA 16	M16	2100055	25	100	1.280,00

 ■ Stahl-Einschlagstift für EA-Einschlaganker

Bezeichnung	Artikel-Nr.	VPE [St]	PE [St]	Euro/PE
Nettopreis				
6	5310067	1	1	4,90
8	5310083	1	1	5,45
10	5310105	1	1	6,60
12	5310121	1	1	8,25
16	5310164	1	1	11,25

Seite 7/12 Artikelgruppe 7

 ■ AB Schwerlast-Anker

Bezeichnung	Gewinde [mm]	Artikel-Nr.	VPE [St]	PE [St]	Euro/PE
Stahl, verzinkt					
AB 20/15	M12	2101121	25	100	613,00
AB 25/15	M16	2101162	12	100	1213,00
Nichtrostender Stahl V4A 					
AB 20/15	M12	2100121	25	100	2.165,00
AB 25/15	M16	2100162	12	100	5.053,00

Seite 7/13 Artikelgruppe 7

 ■ FZA Zykon-Anker mit Konusbolzen

Bezeichnung	Gewinde [mm]	Artikel-Nr.	VPE [St]	PE [St]	Euro/PE
Stahl, verzinkt					
FZA 14 x 60	M10	2161460	10	100	590,00
FZA 18 x 80	M12	2161880	10	100	850,00
FZA 22 x 100	M16	2162201	10	100	2.028,00
Nichtrostender Stahl V4A  Lieferzeit: 5 Arbeitstage ab Werk Kupferzell					
FZA 14 x 60	M10	2166460	10	100	2.153,00
FZA 18 x 80	M12	2166880	10	100	3.007,00
FZA 22 x 100	M16	2167201	10	100	4.640,00

 ■ FZA-I Zykon-Anker mit Innengewinde

Bezeichnung	Gewinde [mm]	Artikel-Nr.	VPE [St]	PE [St]	Euro/PE
Stahl, verzinkt					
FZA 18 x 80 I	M10	2161881	10	100	850,00
FZA 22 x 100 I	M12	2162200	10	100	2.028,00
FZA 22 x 125 I	M12	2162225	10	100	2.437,00
Nichtrostender Stahl V4A  Lieferzeit: 5 Arbeitstage ab Werk Kupferzell					
FZA 18 x 80 I	M10	2166881	10	100	2.564,00
FZA 22 x 100 I	M12	2167200	10	100	4.640,00
FZA 22 x 125 I	M12	2167225	10	100	5.473,00

Seite 7/14 Artikelgruppe 7

■ Bohr- und Setzwerkzeug für FZA und FZA-I

 ■ Bohrer FZUB

Bezeichnung	Artikel-Nr.	VPE [St]	PE [St]	Euro/PE
Nettopreis				
Bohrer				
FZUB 14x60	5301052	1	1	35,00
FZUB 18x80	5301055	1	1	64,00
FZUB 22x100	5301060	1	1	75,00

 ■ Einschlaggerät FZE

Bezeichnung	Artikel-Nr.	VPE [St]	PE [St]	Euro/PE
Nettopreis				
FZE 14	5311108	1	1	8,10
FZE 18	5301110	1	1	8,90
FZE 22	5301115	1	1	9,20

Seite 7/15 Artikelgruppe 7



R Reaktionsanker
Lieferzeit:
 5 Arbeitstage ab Werk Kupferzell

Bezeichnung	Artikel-Nr.	VPE [St]	PE [St]	Euro/PE
Stahl, verzinkt				
RG M8 x 110	2210021	10	1	1,40
RG M10 x 130	2210061	10	1	2,00
RG M10 x 165	2210173	10	1	2,40
RG M12 x 160	2210062	10	1	2,75
RG M16 x 165	2210046	10	1	4,35
Nichtrostender Stahl V4A				
RG M8 x 110 A4	2210063	10	1	4,25
RG M10 x 130 A4	2210064	10	1	7,15
RG M12 x 160 A4	2210065	10	1	9,35



Mörtelpatrone RM
Lieferzeit:
 5 Arbeitstage ab Werk Kupferzell

Bezeichnung	Artikel-Nr.	VPE [St]	PE [St]	Euro/PE
RM 8 für M8	2210018	10	1	3,05
RM 10 für M10	2210035	10	1	3,25
RM 12 für M12	2210037	10	1	3,45
RM 16 für M16	2210019	10	1	5,20



Maschinensetzgerät
Lieferzeit:
 5 Arbeitstage ab Werk Kupferzell

Bezeichnung	Artikel-Nr.	VPE [St]	PE [St]	Euro/PE
RA-SDS	2210060	1	1	18,00

Seite 7/16 Artikelgruppe 7



FHB Highbond-Anker

Bezeichnung	Artikel-Nr.	VPE [St]	PE [St]	Euro/PE
Stahl, verzinkt				
10 x 60 / 10	2210175	10	1	6,15
10 x 60 / 60	2210176	10	1	7,95
12 x 80 / 10	2210177	10	1	7,65
12 x 80 / 50	2210178	10	1	8,75
12 x 80 / 100	2210179	10	1	11,35
12 x 100 / 25	2210180	10	1	9,30
12 x 100 / 60	2210181	10	1	10,65
16 x 125 / 30	2210182	10	1	11,20
Nichtrostender Stahl V4A				
10 x 60 / 10 A4	2210183	10	1	11,10
10 x 60 / 60 A4	2210184	10	1	13,25
12 x 80 / 10 A4	2210185	10	1	14,10
12 x 80 / 50 A4	2210186	10	1	17,00
12 x 80 / 100 A4	2210187	10	1	21,90
12 x 100 / 25 A4	2210188	10	1	19,50
12 x 100 / 60 A4	2210189	10	1	22,40
16 x 125 / 30 A4	2210192	10	1	27,30

Seite 7/17 Artikelgruppe 7



FIS HB 345 S Injektions-Mörtel

Bezeichnung	Artikel-Nr.	VPE [St]	PE [St]	Euro/PE
FIS HB 345 S	2210191	6	1	40,80



FIS S Statikmischer

Bezeichnung	Artikel-Nr.	VPE [St]	PE [St]	Euro/PE
FIS S	2210190	10	1	1,40



FIS AM Auspresspistole

Bezeichnung	Artikel-Nr.	VPE [St]	PE [St]	Euro/PE
FIS AM	2210169	1	1	45,60



FIS Bürstenset

Bezeichnung	Artikel-Nr.	VPE [St]	PE [St]	Euro/PE
FIS Bürstenset	2210194	1	1	3,90



ABG Ausbläser

Bezeichnung	Artikel-Nr.	VPE [St]	PE [St]	Euro/PE
ABG Ausbläser	2210126	1	1	18,50

Seite 7/18 Artikelgruppe 7



FIS V Injektions-Mörtel

Bezeichnung	Artikel-Nr.	VPE [St]	PE [St]	Euro/PE
FIS V 360 S	2210165	6	1	36,10

Seite 7/19 Artikelgruppe 7



FIS S Statikmischer

Bezeichnung	Artikel-Nr.	VPE [St]	PE [St]	Euro/PE
FIS S	2210190	10	1	1,40

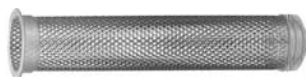

■ FIS H M Anker-/Siebhülse Metall

Bezeichnung	Artikel-Nr.	VPE [St]	PE [St]	Euro/PE
16 x 75 M	2210156	10	100	167,00
16 x 100 M	2210167	10	100	210,00
20 x 75 M	2210196	10	100	231,00
20 x 100 M	2210197	10	100	255,00



■ FIS G M Anker-/Gewindestange

Bezeichnung	Artikel-Nr.	VPE [St]	PE [St]	Euro/PE
Stahl, verzinkt				
8 x 100	2210157	10	100	147,00
8 x 125	2210200	10	100	169,00
10 x 95	2210201	10	100	184,00
10 x 145	2210168	10	100	207,00
12 x 105	2210203	10	100	211,00
12 x 150	2210204	10	100	314,00

Nichtrostender Stahl V4A



8 x 100 A4	2210193	10	100	433,00
10 x 95 A4	2210205	10	100	540,00
10 x 145 A4	2210206	10	100	592,00
12 x 150 A4	2210207	10	100	642,00



■ FIS E Anker-/Innengewindehülse

Bezeichnung	Artikel-Nr.	VPE [St]	PE [St]	Euro/PE
11 x 75 / M8	2210166	10	100	211,00
15 x 100 / M10	2210198	10	100	273,00
15 x 100 / M12	2210199	10	100	273,00

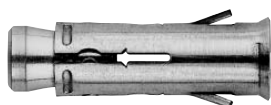

■ Hohldeckenanker FHY

Bezeichnung	Artikel-Nr.	VPE [St]	PE [St]	Euro/PE
FHY M8	2210170	20	100	278,00
FHY M10	2210171	20	100	405,00

■ Kippdübel



Bezeichnung	Gewindestange	Artikel-Nr.	VPE [St]	PE [St]	Euro/PE
① Kippdübel KV					
KV 8-100	M8 x 100	2120081	100	1	2,00
KV 8-200	M8 x 200	2120082	100	1	2,40
KV 8-300	M8 x 300	2120083	100	1	2,85
KV 8-500	M8 x 500	2120085	100	1	3,60

Kippdübel KG

② KG 8	M8 x 100	2128306	100	1	1,40
③ KG 10	M10 x 180	2120518	50	1	5,80



■ Klappdübel SK

Bezeichnung	Gewindestange	Artikel-Nr.	VPE [St]	PE [St]	Euro/PE
SK 10	M10 x 180	2123517	50	1	7,00



■ MEFA-WC-Befestigungen

Bezeichnung	Artikel-Nr.	VPE [St]	PE [St]	Euro/PE
WCB 606 c	8120048	100	1	1,05
WCB 607 c	8120056	100	1	1,20

Seite 7/22

Artikelgruppe 7

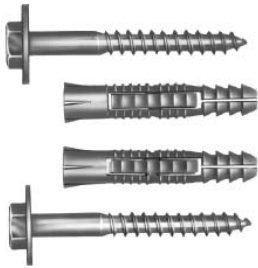

■ MEFA-Laschengarnituren

Bezeichnung	Artikel-Nr.	VPE [St]	PE [St]	Euro/PE
L 1 M8/50 10/44	8110018	100	1	1,10
L 2 M8/60 10/44	8110026	100	1	1,15
L 3 M8/70 10/60	8110034	100	1	1,35
L 4 M8/80 10/60	8110042	100	1	1,35
L 5 M8/90 10/60	8110050	100	1	1,40
L 6 M10/70 12/60	8110069	100	1	1,80
L 7 M10/80 14/80	8110077	100	1	2,15
L 8 M10/100 14/80	8110085	100	1	2,35

Seite 7/23

Artikelgruppe 7

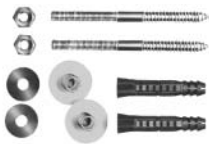

■ MEFA-Montagegarnituren

Bezeichnung	Artikel-Nr.	VPE [St]	PE [St]	Euro/PE
MEFA-Montagegarnitur A und AL				
A	8100012	50	1	1,45
AL	8100047	50	1	2,15
MEFA-Montagegarnitur B und C				
B	8100020	50	1	1,50
C	8100039	50	1	1,45

Seite 7/24

Artikelgruppe 7



■ RHE Atlas-Allzweck-Bohrkonsole

Bezeichnung	Artikel-Nr.	VPE [St]	PE [St]	Euro/PE
RHE 100	6651003	100	100	117,00
RHE 130	6651305	100	100	128,00
RHE 160	6651607	100	100	140,00
RHE 200	6651992	100	100	157,00
RHE 240	6652301	100	100	202,00

Seite 7/24

Artikelgruppe 7



■ Atlas-Radiatoren-Halterungen

Bezeichnung	Artikel-Nr.	VPE [St]	PE [St]	Euro/PE
HRR	6620555	100	100	132,00



■ RHP Atlas-Bohrkonsole

Bezeichnung	Artikel-Nr.	VPE [St]	PE [St]	Euro/PE
RHP 100	6620675	100	100	119,00
RHP 130	6620676	100	100	129,00
RHP 160	6620677	100	100	140,00
RHP 200	6620678	100	100	154,00
RHP 240	6620679	100	100	195,00



■ RHL Atlas-Bohrkonsole

Bezeichnung	Artikel-Nr.	VPE [St]	PE [St]	Euro/PE
RHL 100	6620685	100	100	210,00
RHL 130	6620686	100	100	237,00
RHL 160	6620687	100	100	374,00
RHL 200	6620688	100	100	385,00
RHL 240	6620689	100	100	281,00



■ AHL Atlas-Abstandhalter

Bezeichnung	Artikel-Nr.	VPE [St]	PE [St]	Euro/PE
AHL	6620596	100	100	116,00

Seite 8/1

Artikelgruppe 8



■ Doppio-Lüftungsschelle mit Schalldämmeinlage

Abmessung [DN]	Artikel-Nr.	VPE [St]	PE [St]	Euro/PE
Anschluß: Stufengewinde M8/M10				
DN 71	0449071	50	100	213,00
DN 80	0449080	50	100	222,00
DN 90	0449090	50	100	239,00
DN 100	0449100	50	100	259,00
DN 112	0449112	50	100	273,00
DN 125	0449125	50	100	287,00
DN 140	0449140	25	100	304,00
DN 150	0449150	25	100	316,00
DN 160	0449160	25	100	329,00
DN 180	0449180	25	100	353,00
DN 200	0449200	25	100	376,00
DN 224	0449224	10	100	426,00
DN 250	0449250	10	100	447,00
DN 280	0449280	10	100	514,00
DN 300	0449300	10	100	549,00
DN 315	0449315	10	100	569,00
DN 355	0449355	5	100	768,00
DN 400	0449400	5	100	842,00
DN 450	0449450	5	100	937,00
DN 500	0449500	1	100	1091,00
DN 560	0449560	1	100	1206,00
DN 600	0449600	1	100	1300,00
DN 630	0449630	1	100	1335,00

Seite 8/2-3

Artikelgruppe 8



■ Lüftungsrohrschelle mit Schalldämmeinlage

Abmessung [DN]	Artikel-Nr.	VPE [St]	PE [St]	Euro/PE
Anschluß: Gewinde M8				
DN 71	0430711	1	100	383,00
DN 80	0430801	1	100	394,00
DN 90	0430901	1	100	408,00
DN 100	0431001	1	100	408,00
DN 112	0431121	1	100	450,00
DN 125	0431251	1	100	466,00
DN 140	0431401	1	100	486,00
DN 150	0431501	1	100	504,00
DN 160	0431601	1	100	510,00
DN 180	0431801	1	100	591,00
DN 200	0432001	1	100	614,00
DN 224	0432241	1	100	650,00
DN 250	0432501	1	100	671,00
DN 280	0432801	1	100	734,00
DN 300	0433001	1	100	805,00

Seite 8/2-3

Artikelgruppe 8

Abmessung [DN]	Artikel-Nr.	VPE [St]	PE [St]	Euro/PE
Anschluß: Gewinde M8				
DN 315	0433151	1	100	832,00
DN 355	0433551	1	100	874,00
DN 400	0434001	1	100	935,00
DN 450	0434501	1	100	1065,00
DN 500	0435001	1	100	1165,00
DN 560	0435601	1	100	1307,00

Anschluß: Gewinde M10

DN 71	0430712	1	100	388,00
DN 80	0430802	1	100	399,00
DN 90	0430902	1	100	413,00
DN 100	0431002	1	100	413,00
DN 112	0431122	1	100	455,00
DN 125	0431252	1	100	471,00
DN 140	0431402	1	100	491,00
DN 150	0431502	1	100	509,00
DN 160	0431602	1	100	515,00
DN 180	0431802	1	100	596,00
DN 200	0432002	1	100	619,00
DN 224	0432242	1	100	655,00
DN 250	0432502	1	100	676,00
DN 280	0432802	1	100	739,00
DN 300	0433002	1	100	810,00
DN 315	0433152	1	100	837,00
DN 355	0433552	1	100	879,00
DN 400	0434002	1	100	940,00
DN 450	0434502	1	100	1070,00
DN 500	0435002	1	100	1170,00
DN 560	0435602	1	100	1312,00

Anschluß: Ohne Anschlußgewinde, ohne Schrauben

DN 224	0432240	1	100	559,00
DN 250	0432500	1	100	580,00
DN 280	0432800	1	100	643,00
DN 300	0433000	1	100	706,00
DN 315	0433150	1	100	732,00
DN 355	0433550	1	100	774,00
DN 400	0434000	1	100	837,00
DN 450	0434500	1	100	926,00
DN 500	0435000	1	100	1027,00
DN 560	0435600	1	100	1168,00
DN 630	0436300	1	100	1387,00
DN 710	0437100	1	100	1612,00
DN 800	0438000	1	100	1800,00
DN 900	0439000	1	100	2464,00
DN 1000	0440000	1	100	2793,00
DN 1120	0441200	1	100	2978,00
DN 1250	0442500	1	100	3476,00

Mehrpreis für Anschlußgewinde ab DN 600

M10	1	100	143,00
M12	1	100	160,00
M16	1	100	218,00
1/2" Muffe	1	100	258,00
3/4" Muffe	1	100	283,00

Mehrpreis von Anschlußgewinde M10 auf ...

M12	1	100	17,00
M16	1	100	75,00
1/2" Muffe	1	100	115,00



■ Lüftungsrohrschelle ohne Schalldämmeinlage

Abmessung [DN]	Artikel-Nr.	VPE [St]	PE [St]	Euro/PE
Anschluß: Gewinde M8				
DN 71	0430721	1	100	228,00
DN 80	0430811	1	100	232,00
DN 90	0430911	1	100	235,00
DN 100	0431011	1	100	237,00
DN 112	0431131	1	100	259,00
DN 125	0431261	1	100	265,00
DN 140	0431411	1	100	272,00
DN 150	0431511	1	100	278,00
DN 160	0431611	1	100	315,00
DN 180	0431811	1	100	370,00
DN 200	0432011	1	100	385,00
DN 224	0432251	1	100	400,00
DN 250	0432511	1	100	410,00
DN 280	0432811	1	100	470,00
DN 300	0433011	1	100	490,00
DN 315	0433161	1	100	510,00
DN 355	0433561	1	100	543,00
DN 400	0434011	1	100	577,00
DN 450	0434511	1	100	615,00
DN 500	0435011	1	100	625,00
DN 560	0435611	1	100	685,00

Anschluß: Gewinde M10

DN 71	0430722	1	100	233,00
DN 80	0430812	1	100	237,00
DN 90	0430912	1	100	240,00
DN 100	0431012	1	100	242,00
DN 112	0431132	1	100	264,00
DN 125	0431262	1	100	270,00
DN 140	0431412	1	100	277,00
DN 150	0431512	1	100	283,00
DN 160	0431612	1	100	320,00
DN 180	0431812	1	100	375,00
DN 200	0432012	1	100	390,00
DN 224	0432252	1	100	405,00
DN 250	0432512	1	100	415,00
DN 280	0432812	1	100	475,00
DN 300	0433012	1	100	495,00
DN 315	0433162	1	100	515,00
DN 355	0433562	1	100	548,00
DN 400	0434012	1	100	582,00
DN 450	0434512	1	100	620,00
DN 500	0435012	1	100	630,00
DN 560	0435612	1	100	690,00

Anschluß: Ohne Anschlußgewinde, ohne Schrauben

DN 71	0430720	1	100	157,00
DN 80	0430810	1	100	160,00
DN 90	0430910	1	100	162,00

Fortsetzung →

■ Lüftungsrohrschelle ohne Schalldämmeinlage

Abmessung [DN]	Artikel-Nr.	VPE [St]	PE [St]	Euro/PE
DN 100	0431010	1	100	166,00
DN 112	0431130	1	100	183,00
DN 125	0431260	1	100	187,00
DN 140	0431410	1	100	192,00
DN 150	0431510	1	100	194,00
DN 160	0431610	1	100	197,00
DN 180	0431810	1	100	248,00
DN 200	0432010	1	100	260,00
DN 224	0432250	1	100	284,00
DN 250	0432510	1	100	296,00
DN 280	0432810	1	100	343,00
DN 300	0433010	1	100	352,00
DN 315	0433160	1	100	371,00
DN 355	0433560	1	100	393,00
DN 400	0434010	1	100	414,00
DN 450	0434510	1	100	478,00
DN 500	0435010	1	100	492,00
DN 560	0435610	1	100	521,00
DN 600	0436010	1	100	690,00
DN 630	0436310	1	100	801,00
DN 710	0437110	1	100	925,00
DN 800	0438010	1	100	1035,00
DN 900	0439010	1	100	1312,00
DN 1000	0440010	1	100	1503,00
DN 1120	0441210	1	100	1613,00
DN 1250	0442510	1	100	1829,00



■ Lüftungsrohrschelle mit Dämmelement

Abmessung [DN]	Rohr-Ø [mm]	Artikel-Nr.	VPE [St]	PE [St]	Euro/PE
für Gewindestabanschluß M8 oder M10, mit 1 Gewindestift M8/20, 1 Mutter M8 und 1 Dämmelement M8, vormontiert					
150	155	0448150	1	100	458,00
160	165	0448160	1	100	477,00
180	185	0448180	1	100	513,00
200	205	0448200	1	100	517,00
224	229	0448224	1	100	538,00
250	255	0448250	1	100	542,00
280	285	0448280	1	100	550,00
300	307	0448300	1	100	566,00
315	322	0448315	1	100	581,00
355	362	0448355	1	100	592,00
400	407	0448400	1	100	608,00
450	457	0448450	1	100	655,00
500	507	0448500	1	100	821,00
560	567	0448560	1	100	895,00

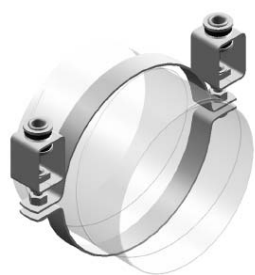

■ Lüftungsrohrschelle mit 2 Dämmelementen

Abmessung [DN]	Rohr-Ø [mm]	Artikel-Nr.	VPE [St]	PE [St]	Euro/PE
für Gewindestabanschluß M8 oder M10, mit 2 Verschußschrauben M8/35, 4 Mutter M8 und 2 Dämmelementen M8, beigelegt					
600	609	0448600	1	100	1108,00
630	639	0448630	1	100	1219,00
710	719	0448710	1	100	1343,00
800	810	0448800	1	100	1453,00

für Gewindestabanschluß M8 oder M10, mit 2 Verschußschrauben M10/35, 4 Mutter M10 und 2 Dämmelementen M10, **beigelegt**

900	910	0448909	1	100	1730,00
1000	1012	0448910	1	100	1921,00
1120	1132	0448911	1	100	2031,00
1250	1262	0448912	1	100	2247,00
1400	1412	0448914	1	100	2886,00
1600	1612	0448916	1	100	3110,00



■ DHL Dämmelement

Bezeichnung	Artikel-Nr.	VPE [St]	PE [St]	Euro/PE
M8	0783301	50	100	200,00
M10	0783302	50	100	208,00



■ Spiralrohr-Abhänger mit Schalldämmung

Bezeichnung	Artikel-Nr.	VPE [St]	PE [St]	Euro/PE
Spiralrohr-Abhänger	0590042	50	100	170,00

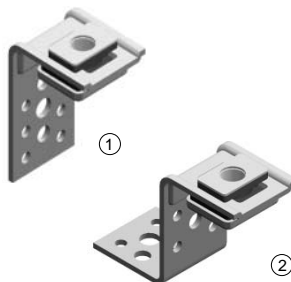

■ Kanalhalter "SD" mit verschiebbarem Schalldämmelement

Hinweis:
Für Gewindestangen M8 und M10

Bezeichnung	Artikel-Nr.	VPE [St]	PE [St]	Euro/PE
① L-Form, mit verschiebbarem Schalldämmelement				
V-SD-L vz. 65 mm	0590020	50	100	105,00
② Z-Form, mit verschiebbarem Schalldämmelement				
V-SD-Z vz. 55 mm	0590028	50	100	105,00

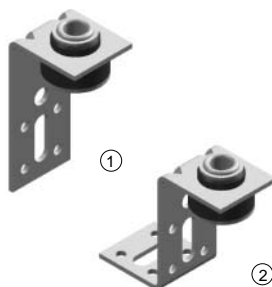

■ Kanalhalter "SD" mit Schalldämmung

Hinweis:
Für Gewindestangen M8 und M10

① L-Form, nicht genietet				
SD-LL 80 mm	0590022	50	100	100,00
① L-Form, genietet				
SD-LSN 80 mm	0590011	50	100	182,00
SD-LLN 80 mm	0590014	50	100	116,00
SD-LLN 165 mm	0590016	50	100	150,00
SD-LLN 255 mm	0590018	50	100	182,00
① L-Form, genietet für Steigkanäle				
SD-LSK 80 mm	0590031	50	100	245,00
② Z-Form, nicht genietet				
SD-ZL 65 mm	0590027	50	100	100,00
② Z-Form, genietet				
SD-ZLN 65 mm	0590026	50	100	116,00
SD-ZSN 65 mm	0590025	50	100	182,00

Seite 8/11 Artikelgruppe 8

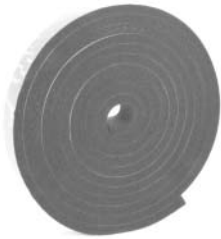

■ Dämmauflage LK, selbstklebend

Abmessung [mm]	Artikel-Nr.	VPE [m]	PE [Rolle]	Euro/PE
LK 25 x 13	7250025	7	1	11,80
LK 35 x 13	7250035	7	1	15,40
LK 45 x 13	7250045	7	1	20,00

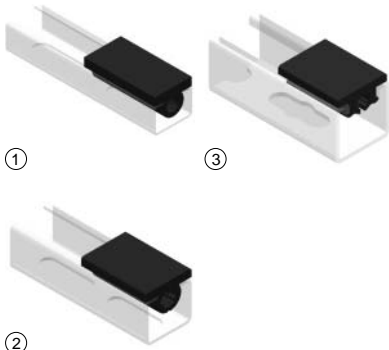

■ Kanalschienen-gummi KG

Abmessung [mm]	Artikel-Nr.	VPE [m/Rolle]	PE [m]	Euro/PE
① KG 27/18	7100019	20	1	3,50
② KG 35	7100035	20	1	4,90
③ KG 45	7100045	20	1	5,35

Stex-Schienengummi: Siehe Seite 12, Artikelgruppe 2

Seite 8/12 Artikelgruppe 8



■ Trapezblechhänger mit Schalldämmung

Bezeichnung	Artikel-Nr.	VPE [St]	PE [St]	Euro/PE
LL A	0783840	100	1	2,40

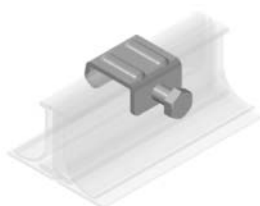

■ Kanalklammer Größe 1

Bezeichnung	Artikel-Nr.	VPE [St]	PE [St]	Euro/PE
Kanalklammer Gr. 1	0593001	50	100	50,00

Seite 8/12 Artikelgruppe 8



■ Bohrschrauben DIN 7504 K

Bezeichnung	Artikel-Nr.	VPE [St]	PE [St]	Euro/PE
Form K vz. 4,2 x 13	3700413	500	100	5,15
Form K vz. 4,2 x 16	3700416	500	100	6,20
Form K vz. 4,2 x 19	3700419	500	100	6,80

Seite 8/13 Artikelgruppe 8



■ Kanaldichtband

Bezeichnung [mm]	Artikel-Nr.	VPE [Rollen]	PE [Rolle]	Euro/PE
9 x 4	725110904	5	1	2,50
12 x 4	725111204	5	1	3,30
15 x 4	725111504	5	1	4,20



■ Kanaldichtpaste

Bezeichnung	Artikel-Nr.	VPE [St]	PE [St]	Euro/PE
310 ml Kartusche	725100310	20	1	3,25

■ Kaltschrumpfband



Bezeichnung [mm]	Artikel-Nr.	VPE [Rollen]	PE [Rolle]	Euro/PE
50	725120050	20	1	21,30
75	725120070	20	1	29,30
100	725120100	10	1	41,50



■ **Polycell 2000,
PE-Isolierschlauch**

Isolierdicke x Rohr-Ø [mm]	Artikel-Nr.	VPE [m]	PE [m]	Euro/PE
9 x 12	7720120	420	1	1,25
13 x 12	7730120	260	1	1,85
20 x 12	7740123	120	1	3,05
27 x 12	7750120	80	1	3,45
9 x 15	7720150	320	1	1,30
13 x 15	7730150	220	1	1,85
20 x 15	7740158	150	1	3,20
27 x 15	7750150	96	1	3,70
9 x 18	7720180	300	1	1,30
13 x 18	7730180	200	1	2,05
20 x 18	7740182	140	1	3,30
26 x 18	7750180	80	1	4,75
9 x 22	7720220	260	1	1,35
13 x 22	7730220	170	1	2,25
20 x 22	7740220	110	1	3,55
26 x 22	7750220	80	1	5,20
9 x 28	7720280	200	1	1,40
13 x 28	7730280	130	1	2,80
20 x 28	7740298	96	1	4,10
25 x 28	7750285	70	1	5,35
9 x 34	7720340	150	1	1,50
13 x 34	7730340	110	1	3,00
20 x 34	7740344	70	1	4,60
25 x 34	7750340	60	1	7,15
9 x 42	7720420	120	1	1,80
13 x 42	7730420	90	1	3,05
20 x 42	7740425	62	1	7,00
25 x 42	7750420	50	1	8,60
9 x 48	7720480	60	1	2,30
13 x 48	7730480	50	1	3,65
20 x 48	7740484	54	1	7,95
25 x 48	7750481	42	1	12,05
9 x 54	7720540	70	1	2,40
13 x 54	7730540	56	1	3,75
20 x 54	7740549	48	1	9,45
9 x 57	7720570	44	1	2,45
13 x 57	7730570	52	1	3,80
20 x 57	7740573	48	1	9,50
25 x 57	7750579	34	1	13,15
9 x 60	7720600	60	1	2,65
13 x 60	7730600	38	1	4,05
20 x 60	7740603	40	1	9,50
25 x 60	7750609	34	1	13,65
9 x 76	7720760	48	1	4,25
13 x 76	7730760	22	1	5,80
20 x 76	7740778	30	1	10,75
25 x 76	7750765	24	1	16,45
9 x 89	7720891	34	1	4,80
13 x 89	7730890	20	1	6,35

Fortsetzung →

Isolierdicke x Rohr-Ø [mm]	Artikel-Nr.	VPE [m]	PE [m]	Euro/PE
20 x 89	7740891	24	1	19,00
25 x 89	7750897	18	1	22,50
9 x 102	7721020	28	1	5,05
13 x 102	7731020	18	1	16,35
9 x 108	7721080	26	1	5,25
13 x 108	7731080	14	1	16,35
9 x 114	7721140	24	1	5,60
13 x 114	7731141	14	1	16,90



■ **Steinojet, PE-Isolierschlauch
mit Schnellklebeverschluß**

Isolierdicke x Rohr-Ø [mm]	Artikel-Nr.	VPE [m]	PE [m]	Euro/PE
9 x 12	7780312	180	1	2,20
13 x 12	7780412	116	1	2,90
9 x 15	7780315	140	1	2,20
13 x 15	7780415	96	1	2,90
20 x 15	7780215	60	1	3,65
9 x 18	7780318	126	1	2,35
13 x 18	7780418	90	1	2,95
20 x 18	7780218	60	1	4,10
9 x 22	7780322	100	1	2,45
13 x 22	7780422	76	1	3,15
20 x 22	7780222	50	1	4,30
9 x 28	7780328	90	1	2,80
13 x 28	7780428	60	1	3,40
20 x 28	7780228	40	1	4,80
9 x 34	7780334	70	1	3,05
13 x 34	7780434	48	1	4,10
20 x 34	7780234	36	1	5,30
9 x 42	7780342	50	1	3,55
13 x 42	7780442	76	1	4,85
20 x 42	7780242	30	1	6,10
9 x 48	7780348	44	1	4,20
13 x 48	7780448	60	1	5,45
20 x 48	7780248	24	1	7,05

Seite 9/3

Artikelgruppe 9

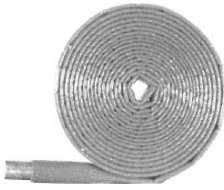

■ Steinoflex-Isolierschlauch

Isolierdicke x Rohr-Ø [mm]	Artikel-Nr.	VPE [m]	PE [m]	Euro/PE
4 x 15	7794160	100/800	1	0,90
4 x 18	7794195	100/800	1	1,00
4 x 22	7794233	100/800	1	1,20
4 x 28	7794292	100/600	1	1,30
4 x 34	7794357	100/600	1	1,45
4 x 42	7794438	100/400	1	1,60



■ Isolierschlauch für Abflußrohre mit Schutzmantel PE, rot

Isolierdicke x Rohr-Ø [mm]	Artikel-Nr.	VPE [m]	PE [m]	Euro/PE
NW 50	7796505	100	1	2,00
NW 70	7796705	80	1	2,25
NW 100	7797005	60	1	2,85
NW 125	7797255	50	1	4,55
NW 150	7797505	40	1	6,80

Seite 9/4

Artikelgruppe 9



■ Steinoflex-Isolierschlauch Ultra mit Schutzmantel PE, rot

Isolierdicke x Rohr-Ø [mm]	Artikel-Nr.	VPE [m]	PE [m]	Euro/PE
9 x 10	7790910	170	1	2,30
9 x 12	7790912	170	1	2,30
9 x 15	7790915	150	1	2,35
9 x 18	7790918	140	1	2,50
9 x 22	7790922	100	1	2,65
9 x 28	7790928	80	1	3,15
9 x 34	7790934	60	1	3,55
13 x 10	7792010	106	1	2,80
13 x 12	7792012	106	1	2,80
13 x 15	7792015	100	1	3,05
13 x 18	7792018	100	1	3,20
13 x 22	7792022	80	1	3,40
13 x 28	7792028	60	1	3,75
13 x 34	7792034	40	1	4,65
20 x 12	7793122	70	1	3,35
20 x 15	7793159	60	1	3,75
20 x 18	7793183	56	1	4,70
20 x 22	7793226	40	1	4,75
20 x 28	7793280	40	1	5,15

Seite 9/5

Artikelgruppe 9



■ Steinoflex-Dämmblock

Isolierdicke x Rohr-Ø [mm]	Artikel-Nr.	VPE [m]	PE [m]	Euro/PE
13 x 15	7771315	120	1	3,55
13 x 18	7771318	120	1	3,80
13 x 22	7771322	80	1	4,05
13 x 28	7771328	70	1	4,80
27 x 15	7772715	70	1	6,70
26 x 18	7772618	70	1	7,35
26 x 22	7772622	50	1	8,30
25 x 28	7772528	50	1	9,10

Seite 9/6

Artikelgruppe 9



■ Isolierklebeband SK, grau, selbstklebend

Isolierstärke [mm]	Artikel-Nr.	VPE [Rollen]	PE [Rolle]	Euro/PE
3 mm	7320122	15	1	16,65



■ Isolierband NK, rot, beschichtet

Isolierstärke [mm]	Artikel-Nr.	VPE [Rollen]	PE [St]	Euro/PE
2 mm	7320097	2 x 5m	1 VPE	10,30



■ Isolierklebeband SK, rot, beschichtet, selbstklebend

Isolierstärke [mm]	Artikel-Nr.	VPE [m]	PE [Rolle]	Euro/PE
4 mm	7320105	5	1	10,30

■ Verarbeitungszubehör

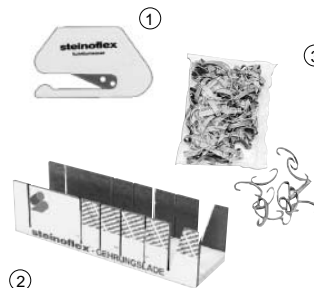

Lieferzeit:
5 Arbeitstage ab
Werk Kupferzell

Bezeichnung	Artikel-Nr.	VPE [St]	PE [St]	Euro/PE
① Mini-Schlitzmesser	5929030	1	1	1,10
② Gehrungslade	5929040	1	1	10,55
③ Klammern	5929059	100	100	2,40

Nettopreis

Seite 9/7

Artikelgruppe 9



■ **Isolierschlauch Kautschuk W**

Isolierdicke x Rohr-Ø [mm]	Artikel-Nr.	VPE [m]	PE [m]	Euro/PE
9 x 15	7090915	160	1	2,25
13 x 15	7091315	130	1	2,45
24 x 15	7092415	40	1	6,75
9 x 18	7090918	140	1	2,35
13 x 18	7091318	100	1	2,65
24 x 18	7092418	36	1	8,05
9 x 22	7090922	120	1	2,55
13 x 22	7091322	90	1	2,90
24 x 22	7092422	30	1	8,50
9 x 28	7090928	76	1	2,90
13 x 28	7091328	60	1	3,55
24 x 28	7092428	30	1	9,65
36 x 28	7093628	18	1	16,60
9 x 34	7090934	80	1	3,30
20 x 34	7092034	32	1	6,10
36 x 34	7093634	16	1	19,15
9 x 42	7090942	70	1	3,55
20 x 42	7092042	28	1	7,15

Seite 9/8

Artikelgruppe 9



■ **Isolierschlauch Kautschuk K**

Isolierdicke x Rohr-Ø [mm]	Artikel-Nr.	VPE [m]	PE [m]	Euro/PE
9 x 12	7080912	170	1	1,90
13 x 12	7081312	110	1	2,20
9 x 15	7080915	140	1	2,00
13 x 15	7081315	90	1	2,30
9 x 18	7080918	120	1	2,10
13 x 18	7081318	80	1	2,50
20 x 18	7082518	32	1	5,55
9 x 22	7080922	100	1	2,30
13 x 22	7081322	70	1	2,70
9 x 28	7080928	80	1	2,60
13 x 28	7081328	54	1	3,40
20 x 28	7082028	34	1	4,75
9 x 34	7080934	60	1	2,90
20 x 34	7082034	30	1	5,80
9 x 42	7080942	50	1	3,50
20 x 42	7082042	24	1	6,85

Seite 9/9

Artikelgruppe 9

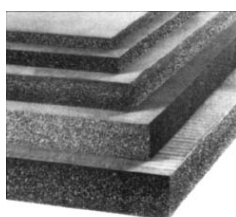

■ **Isolierplatte K**

Isolierdicke [mm]	LxB [m]	Artikel-Nr.	VPE [m²]	PE [m²]	Euro/PE
selbstklebend, endlos					
6	30 x 1	7080106	30	1	31,10
9	20 x 1	7080109	20	1	34,80
13	14 x 1	7080113	14	1	40,20
16	12 x 1	7080116	12	1	47,50
19	10 x 1	7080119	10	1	53,30
25	8 x 1	7080125	8	1	68,65
32	6 x 1	7080132	6	1	83,65

Seite 9/10

Artikelgruppe 9



■ **Isolierstreifen selbstklebend**
für Isolierschlauch Kautschuk W

Bezeichnung	Artikel-Nr.	VPE [Rolle]	PE [Rolle]	Euro/PE
grau 3 mm	7099999	1	1	26,35



■ **Gewebe-Selbstklebeband**

Bezeichnung	Artikel-Nr.	VPE [Rolle]	PE [Rolle]	Euro/PE
schwarz 38 mm	7320079	1	1	31,65
grau 38 mm	7320087	1	1	31,65
rot 38 mm	7320082	1	1	31,65

Seite 9/10

Artikelgruppe 9



■ Klebeband, transparent

Bezeichnung	Artikel-Nr.	VPE [Rolle]	PE [Rolle]	Euro/PE
transparent 38 mm	5921058	1	1	4,40



■ Alu-Selbstklebeband AF Aluminiumbedampft

Bezeichnung	Artikel-Nr.	VPE [Rolle]	PE [Rolle]	Euro/PE
alu	7320111	1	1	20,05



■ Spezialkleber siliconfrei

Bezeichnung	Artikel-Nr.	VPE [St]	PE [St]	Euro/PE
0,250 l mit Pinsel	7970025	1	Dose	11,85
0,425 l ohne Pinsel	7970056	1	Dose	14,80
2,500 l ohne Pinsel	7970071	1	Kanister	57,45

Seite 9/11

Artikelgruppe 9



■ Isolierschlauch-Polyester mit Dampfsperffolie

Rohr-Ø [mm]	Isolierdicke [mm]	Artikel-Nr.	VPE [m]	PE [m]	Euro/PE
12-15	4	7300107	250	1	0,90
18	4	7300018	250	1	1,05
22	4	7300026	250	1	1,20
28	4	7300034	250	1	1,30
35	4	7300042	250	1	1,50
42	4	7300050	50	1	1,65
48	4	7300069	50	1	1,90
60	4	7300077	50	1	2,00
75-80	4	7302908	50	1	2,25
81-90	4	7303007	50	1	2,60
108-120	4	7303106	50	1	3,20

Seite 9/11

Artikelgruppe 9



■ Isolierschlauch-Polyester mit Dampfsperffolie

Rohr-Ø [mm]	Isolierdicke [mm]	Artikel-Nr.	VPE [m]	PE [m]	Euro/PE
75-80	10	7303904	50	1	7,50
81-90	10	7304003	50	1	9,50
108-120	10	7304102	50	1	10,55



■ Isolierschlauch-Polyester ohne Dampfsperffolie

Rohr-Ø [mm]	Isolierdicke [mm]	Artikel-Nr.	VPE [m]	PE [m]	Euro/PE
12-15	4	7307152	50	1	0,80
18	4	7307012	50	1	0,90
22	4	7307020	50	1	0,95
28	4	7307039	50	1	1,10
35	4	7307047	50	1	1,30
42	4	7307055	50	1	1,50
48	4	7307063	50	1	1,70
60	4	7307071	50	1	1,85

Seite 9/12

Artikelgruppe 9



■ Isolierstreifen-Polyester mit Dampfsperffolie

Breite [mm]	Isolierdicke [mm]	Artikel-Nr.	VPE [m]	PE [m]	Euro/PE
ohne Klebestreifen					
70	2	7310056	50	1	0,40
70	4	7310064	50	1	0,65
100	2	7310102	50	1	0,65
100	4	7310110	50	1	0,95
mit Klebestreifen					
70	2	7313071	50	1	1,70
70	4	7313578	50	1	1,85
100	2	7313101	50	1	2,15
100	4	7313608	50	1	2,35

Seite 9/12

Artikelgruppe 9



■ Isolierstreifen-Polyester ohne Dampfsperffolie

Breite [mm]	Isolierdicke [mm]	Artikel-Nr.	VPE [m]	PE [m]	Euro/PE
ohne Klebestreifen					
70	2	7310013	50	1	0,35
70	4	7309953	50	1	0,60
100	2	7310021	50	1	0,45
100	4	7309961	50	1	0,80
mit Klebestreifen					
70	2	7312075	50	1	1,35
70	4	7312571	50	1	1,55
100	2	7312105	50	1	1,75
100	4	7312601	50	1	1,95

Seite 10/1

Artikelgruppe 10



■ Locher Paste 2000

Bezeichnung	Artikel-Nr.	VPE [St]	PE [St]	Euro/PE
Tube 250 g	5890010	20	1	4,90
Dose 400 g	5890020	18	1	7,85
Dose 850 g	5890030	18	1	13,15

Seite 10/2

Artikelgruppe 10



■ Locher Paste Solar

Bezeichnung	Artikel-Nr.	VPE [St]	PE [St]	Euro/PE
Dose 250 g	5902003	20	1	28,10

Seite 10/2

Artikelgruppe 10



■ Zinkspray -Zinkgründung- (Zinkgrau)

Bezeichnung	Artikel-Nr.	VPE [St]	PE [St]	Euro/PE
Nettopreis				
Dose 400 ml	5920001	1	1	9,00
		12	1	6,90
		36	1	5,80
		60	1	4,85

Seite 10/3

Artikelgruppe 10



■ Zinkausbesserungs-spray (Silber, hell)

Bezeichnung	Artikel-Nr.	VPE [St]	PE [St]	Euro/PE
Nettopreis				
Dose 400 ml	5920002	1	1	8,80
		12	1	6,75
		36	1	5,60
		60	1	4,75

Fortsetzung →

Seite 10/3

Artikelgruppe 10



■ **SDS-plus
Hi-Performance-Bohrer**

Bohrer-Ø [mm]	Länge [m]	Artikel-Nr.	VPE [St]	PE [St]	Euro/PE
5,0	110	51305110	1	1	4,95
5,0	160	51305150	1	1	8,15
6,0	110	51306110	1	1	5,10
6,0	160	51306160	1	1	6,10
6,0	210	51306210	1	1	9,20
6,0	260	51306260	1	1	10,50
6,5	110	51307110	1	1	6,25
8,0	110	51308110	1	1	6,95
8,0	160	51308160	1	1	7,55
8,0	210	51308210	1	1	8,85
8,0	260	51308260	1	1	11,05
10,0	160	51310160	1	1	8,40
10,0	210	51310210	1	1	10,50
10,0	260	51310260	1	1	12,50
11,0	160	51311160	1	1	9,85
12,0	160	51312160	1	1	9,30
12,0	210	51312200	1	1	15,95
12,0	260	51312266	1	1	14,60
13,0	160	51313160	1	1	11,95
14,0	210	51314200	1	1	14,55
14,0	310	51314300	1	1	17,05
15,0	160	51315160	1	1	15,40
16,0	210	51316200	1	1	28,70
16,0	310	51316300	1	1	21,25
18,0	300	51318300	1	1	39,20
20,0	200	51320200	1	1	38,70
20,0	300	51320300	1	1	44,40
22,0	250	51322250	1	1	55,90

Seite 10/4

Artikelgruppe 10



■ **Trennscheibe
MEFAFLEX**

Bezeichnung	Ø [mm]	Artikel-Nr.	VPE [St]	PE [St]	Euro/PE
MEFAFLEX	125	5370125	10	1	1,75

Nettopreis

Seite 11/1

Artikelgruppe 11

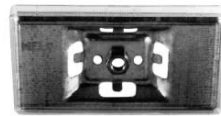

■ **Info-Schildersystem Halter**

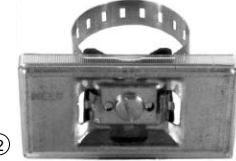
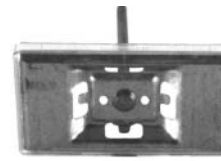

Bezeichnung	Artikel-Nr.	VPE [St]	PE [St]	Euro/PE
① Schraubhalter	5030230	25	1	1,55
② Schweißhalter	5030220	25	1	1,85
③ Universalhalter	5030210	25	1	2,80



■ **Info-Leerschilder**

Bezeichnung	Artikel-Nr.	VPE [St]	PE [St]	Euro/PE
rot	5030110	25	1	0,70
blau	5030120	25	1	0,70
grün	5030130	25	1	0,70
gelb	5030140	25	1	0,70
grau	5030150	25	1	0,70
weiß	5030160	25	1	0,70



■ **Zubehör**

Bezeichnung	Artikel-Nr.	VPE [St]	PE [St]	Euro/PE
Spannband, verzinkt	5030300	5 m	1 VPE	7,00
Kunststoffdeckel	5030215	1	1	0,80

Seite 11/2

Artikelgruppe 11

Bezeichnung	Artikel-Nr.	VPE [St]	PE [St]	Euro/PE
Info-Schriftleisten, weiß				
Leerleiste	5030000	1	1	0,40
Firmeneindruck auf Schilder				Nettopreis
Klischeekosten bis 3 Zeilen Text				50,00

Druckkosten, einfarbig	Artikel-Nr.	VPE [St]	PE [St]	Nettopreis
	0000041	ab 50	1	0,80
		ab 100	1	0,50
		ab 250	1	0,25
		ab 500	1	0,15



■ Rohrschlaufe "S", verzinkt



DN [Zoll / mm]	Anschluß- gewinde	Artikel-Nr.	VPE [St]	PE [St]	Euro/PE
Anlagen nach VdS-Richtlinien					
1/2" *	M8	0470221	100	100	84,00
3/4" *	M8	0470271	100	100	84,00
1"	M8	4700034	100	100	84,00
1 1/4"	M8	4700042	50	100	84,00
1 1/2"	M8	4700048	50	100	92,00
2"	M8	4700060	50	100	92,00

DN	Anschluß- gewinde	Artikel-Nr.	VPE [St]	PE [St]	Euro/PE
Anlagen nach FM- und VdS-Richtlinien					
2 1/2"	M10	4700076	25	100	192,00
3"	M10	4700089	25	100	200,00
108 *	M10	0471082	25	100	286,00
4"	M10	4700114	25	100	286,00
133 *	M12	0471333	25	100	390,00
5"	M12	4700140	25	100	390,00
159 *	M12	0471593	25	100	430,00
6"	M12	4700165	25	100	430,00
8"	M16	4700219	10	100	660,00

DN	Anschluß- gewinde	Artikel-Nr.	VPE [St]	PE [St]	Euro/PE
Anlagen nach FM-Richtlinien					
1/2" *	M10	0470222	100	100	92,00
3/4" *	M10	0470272	100	100	92,00
1"	M10	4701034	100	100	92,00
1 1/4"	M10	4701042	50	100	92,00
1 1/2"	M10	4701048	50	100	99,00
2"	M10	4701060	50	100	99,00

* Ausführung wie Vorgängermodell



■ Rohrschelle Typ "SP", zweiteilig, verzinkt

Zugelassen nach den VdS-Richtlinien für Sprinkleranlagen VdS 2092, Planung und Einbau

Spannbereich [mm]	Artikel-Nr.	VPE [St]	PE [St]	Euro/PE	≥ 10 St.	≥ 25 St.
Anschluß: M8						
20-23	1/2"	0473022	1	100	304,00	273,00
25-28	3/4"	0473027	1	100	305,00	274,00
32-35	1"	0473034	1	100	306,00	275,00
41-46	1 1/4"	0473042	1	100	319,00	287,00
48-55	1 1/2"	0473048	1	100	330,00	297,00
57-61	2"	0473060	1	100	337,00	303,00

■ Rohrschelle Typ "SP", zweiteilig, verzinkt

Spannbereich [mm]	Artikel-Nr.	VPE [St]	PE [St]	Euro/PE	≥ 10 St.	≥ 25 St.
Anschluß: M10						
20-23	1/2"	0474022	1	100	304,00	273,00
25-28	3/4"	0474027	1	100	305,00	274,00
32-35	1"	0474034	1	100	306,00	275,00
41-46	1 1/4"	0474042	1	100	319,00	287,00
48-55	1 1/2"	0474048	1	100	330,00	297,00
57-61	2"	0474060	1	100	337,00	303,00
70-76	2 1/2"	0474076	1	100	469,00	422,00
84-90	3"	0475089	1	100	503,00	453,00
105-112		0475108	1	100	395,00	355,00
114-118	4"	0475114	1	100	538,00	484,00

Spannbereich [mm]	Artikel-Nr.	VPE [St]	PE [St]	Euro/PE	≥ 10 St.	≥ 25 St.
Anschluß: M12						
133		0476133	1	100	689,00	620,00
140	5"	0476140	1	100	818,00	737,00
159		0476159	1	100	882,00	794,00
164-168		0476168	1	100	896,00	807,00

Spannbereich [mm]	Artikel-Nr.	VPE [St]	PE [St]	Euro/PE	≥ 10 St.	≥ 25 St.
Anschluß: M16						
219	8"	0477219	1	100	2888,00	2600,00

Spannbereich [mm]	Artikel-Nr.	VPE [St]	PE [St]	Euro/PE	≥ 10 St.	≥ 25 St.
Anschluß: M20						
273	10"	0478273	1	100	3349,00	3014,00



■ Rohrschlaufe "R", einteilig, verzinkt

- Montagezubehör:
- Adapter-Blattschraube
 - Adapter-Befestigungsöse
- (s. unten)

Abmessung [mm]	Rohr-Ø [mm]	Artikel-Nr.	VPE [St]	PE [St]	Euro/PE
1/2"	21,3	0340014	1	100	3,60
3/4"	26,9	0340022	1	100	3,60
1"	33,7	0340030	1	100	3,60
1 1/4"	42,4	0340049	1	100	4,15
1 1/2"	48,3	0340057	1	100	4,15
2"	60,3	0340065	1	100	4,60

Abmessung [mm]	Rohr-Ø [mm]	Artikel-Nr.	VPE [St]	PE [St]	Euro/PE
Adapter-Blattschraube					
BA 8x20	M8x20	0353820	50	100	6,50
BA 8x40	M8x40	0353840	50	100	7,20
Adapter-Befestigungsöse					
BO 25- 8	M8	0350152	50	100	11,00
BO 25-10	M10	0350174	50	100	11,00

C-Profileschienen und Konsolen:
Siehe Seite 15/16 und 22/23, Artikelgruppe 2

Fortsetzung →

MEFA Befestigungs- und Montagesysteme GmbH

Schillerstraße 15, D-74635 Kupferzell

Telefon: +49 (0) 7944-64-0

Telefax: +49 (0) 7944-64-37

Email: info@mefa.de

URL: www.mefa.de



MEFA