

Kiskojärjestelmä  
**Stex 35**

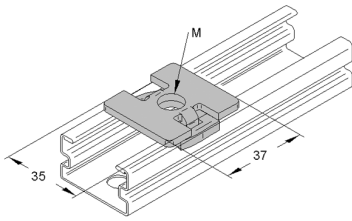



## Stex 35 asennuslevy

tiedot	LVI-nro/koodi	kpl/ltk	€/kpl/alv 0%
M8	3216206/1272010	50	1,00
M10	3216207/1272011	50	1,00

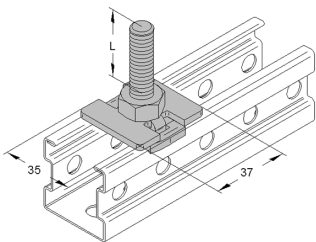

## Stex 35 asennuslevy kierrepultilla

malli	LVI-nro/koodi	kpl/ltk	€/kpl/alv 0%
M8/50	3216211/1278050	50	1,60
M8/70	3216212/1278070	50	1,65
M8/90	3216213/1278090	50	1,70
M8/110	3216214/1278110	25	1,75
M8/130	3216215/1278130	25	1,80
M10/50	3216216/1270050	50	1,65
M10/70	3216217/1270070	50	1,70
M10/90	3216218/1270090	50	1,75
M10/110	3216219/1270110	25	1,85
M10/130	3216220/1270130	25	1,95

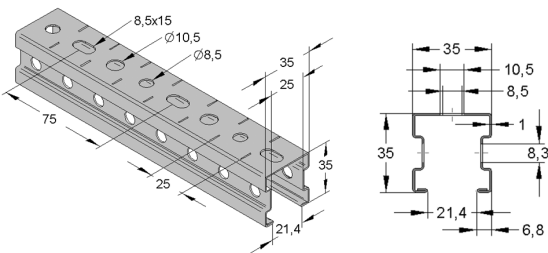

## Stex 35 asennuskisko 35/30/1,0

malli	LVI-nro/koodi	m/nippu	€/m/alv 0%
35/30/1,0 x 2 m	3216202/1273535	12	4,75
35/30/1,0 x 3 m	3216204/1273539	18	4,75

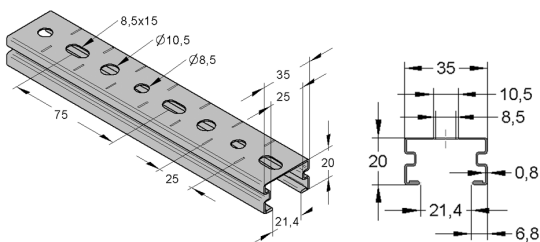

## Stex 35 asennuskisko 35/20/0,8

malli	LVI-nro/koodi	m/nippu	€/m/alv 0%
35/20/0,8 x 2 m	3216201/1273520	12	3,60
35/20/0,8 x 3 m	3216203/1273523	18	3,60

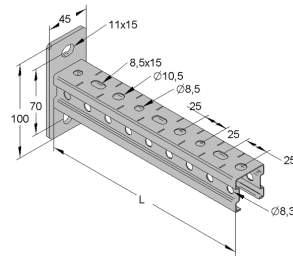

## Stex 35 konsolikannake

malli	LVI-nro/koodi	kpl/ltk	€/kpl/alv 0%
35/35/1,0 x 150 mm	-/1274150	25	4,96
35/35/1,0 x 225 mm	3216222/1274225	25	5,45
35/35/1,0 x 300 mm	3216223/1274300	25	6,05
35/35/1,0 x 375 mm	3216224/1274375	25	6,80
35/35/1,0 x 450 mm	3216225/1274450	25	8,55
35/35/1,0 x 525 mm	3216226/1274525	20	9,20
35/35/1,0 x 600 mm	-/1274600		
35/35/1,0 x 700 mm	3216227/1274700	10	9,50

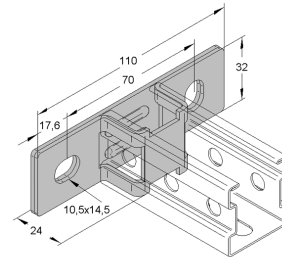

## Stex 35 päätykannake

malli	LVI-nro/koodi	kpl/ltk	€/kpl/alv 0%
35/35	3216221/1272021	10	4,70

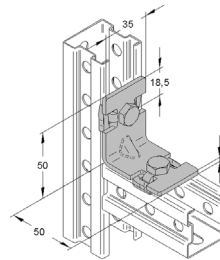

## Stex 35 kulmakappale

malli	LVI-nro/koodi	kpl/ltk	€/kpl/alv 0%
Kulmakappale	3216230/1272012	25	3,60

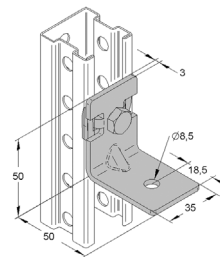

## Stex 35 yleiskulmakappale

malli	LVI-nro/koodi	kpl/ltk	€/kpl/alv 0%
yleiskulma	3126213/1272018	25	2,65
yleiskulmapaketti*	3126233/1272022	25	3,85

\*sisältää yleiskulman, M8 x 20 ruuvin, Stex M8 esiasennettuna

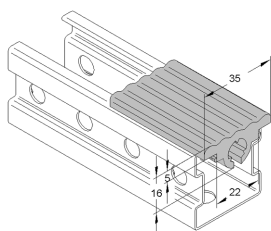

## Stex 35 kiskokumi

malli	LVI-nro/koodi	kp/ltk	€/kpl/alv 0%
kiskokumi (m)	3216235/1272019	20 m	3,50/m
kiskokumi pala	3216239/1272020	50 kpl	0,21 kpl

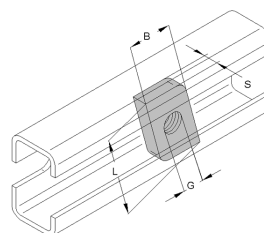

## Stex 35 kierrelevy

malli	koodi	kp/ltk	€/kpl/alv 0%
M8, 38x17	0750077	100	46,00
M10, 38x17	0750085	100	53,00
M12, 38x17	0750093	100	59,00

Yhteensopivuu: 35/21, 36/40, Stex 35/35, Stex 35/20

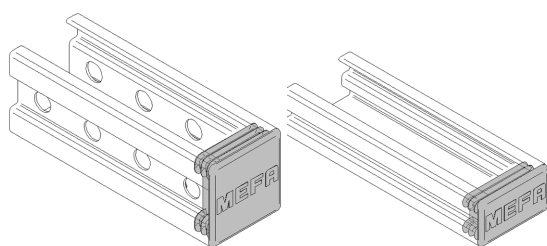

## Stex 35 suojatulppa

malli	LVI-nro/koodi	kp/ltk	€/kpl/alv 0%
35/35	3216238/1272016	50	0,44
35/20	3216239/1272016	50	0,39

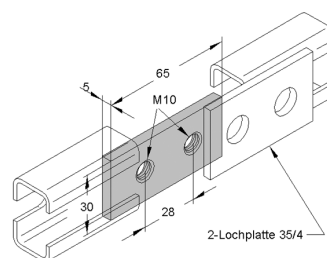

## Kierrelevy 35/4, 2-reikäinen

malli	koodi	kp/ltk	€/kpl/alv 0%
65x30x5 mm, M10	0816092	50	1,60

Yhteensopivuu: 35 mm, 36 mm, Stex 35/20, 35/35

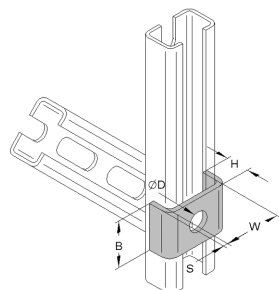

## Profiilikiinnike 35

malli	LVI-nro/koodi	kp/ltk	€/kpl/alv 0%
13,0 mm	0809501	100	0,55
10,5 mm	0809503	100	0,55

Yhteensopivuu: 35 mm, 36 mm, Stex 35/20, 35/35

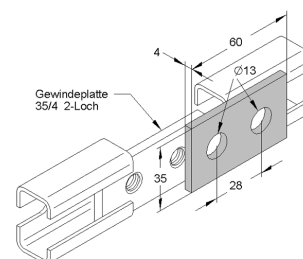

## Reikälevy 35/4, 2-reikäinen

malli	koodi	kp/ltk	€/kpl/alv 0%
65x35x4 mm	0816086	25	1,15

Yhteensopivuu: 35 mm, 36 mm, Stex 35/20, 35/35

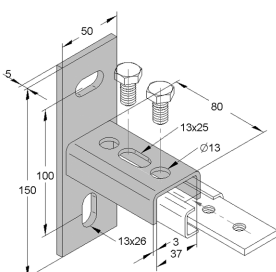

## Kiinnike 35

malli	koodi	kp/ltk	€/kpl/alv 0%
pysty	080213402	25	8,80
vaaka	080213502	25	9,40

Yhteensopivuu: 35 mm, 36 mm, Stex 35/20, 35/35

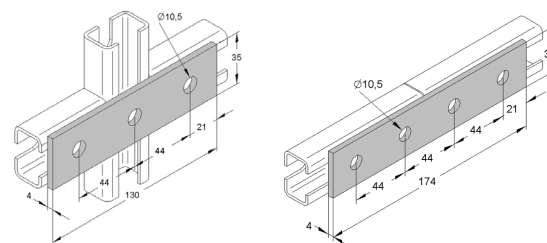

## Jatkokappale 35, 3-reikäinen, 4-reikäinen

malli	koodi	kp/ltk	€/kpl/alv 0%
130x35x4 mm	0814457	25	1,85
174x35x4 mm	0814465	25	2,20

Yhteensopivuu: 35 mm, 36 mm, Stex 35/20, 35/35

# Mefa Stex 35

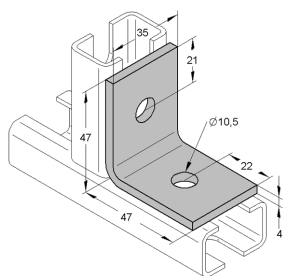

## Kulma 35, 2-reikäinen

malli	koodi	kp/ltk	€/kp/alv 0%
35/4 2-reikäinen	0814510	1	1,30

47x35x4 mm

Yhteensopivuus: 35 mm, 36 mm, Stex 35/20, 35/35

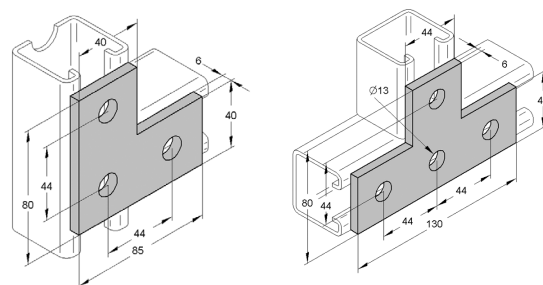

## Kulmatuki 35

malli	koodi	kp/ltk	€/kp/alv 0%
35/4 L-muotoinen	0814430	1	4,15

85x80x4 mm

35/4 T-muotoinen	0814449	1	5,50
------------------	---------	---	------

130x80x4 mm

Yhteensopivuus: 35 mm, 36 mm, Stex 35/20, 35/35

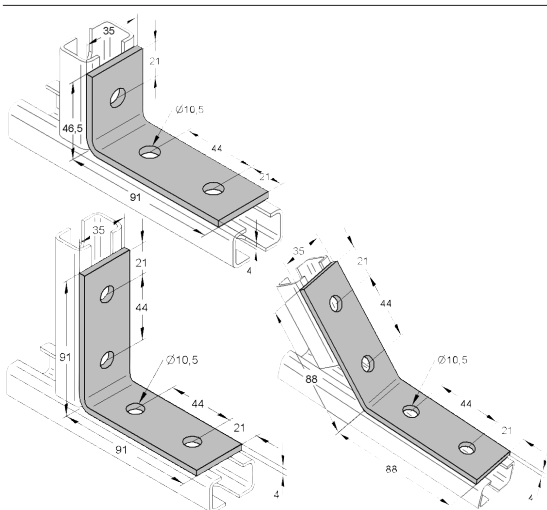

## Kulma 35/4

malli	koodi	kp/ltk	€/kp/alv 0%
35/4 3-reikäinen K	0814520	50	1,50

91x35x4 mm

35/4 4-reikäinen 90°	0814530	50	1,90
----------------------	---------	----	------

91x35x4 mm

35/4 4-reikäinen 135°	0814540	50	2,05
-----------------------	---------	----	------

88x35x4 mm

Yhteensopivuus: 35 mm, 36 mm, Stex 35/20, 35/35

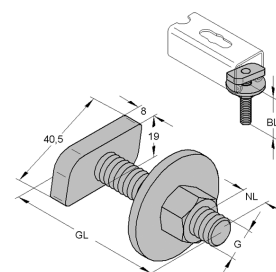

## Lukituskiinnike 35

malli	koodi	kp/ltk	€/kp/alv 0%
M8x30	0697044	50	88,00
M8x40	0697051	50	89,00
M8x50	0697060	50	90,00
M8x70	0697075	50	93,00
M10x30	0697540	50	95,00
M10x40	0697560	50	98,00
M10x50	0697570	50	100,00
M10x70	0697590	50	107,00
M12x35	0698040	50	132,00
M12x50	0698050	50	138,00
M12x70	0698070	50	144,00

Yhteensopivuus: 35/21, 36/40, Stex 35/35, Stex 35/20

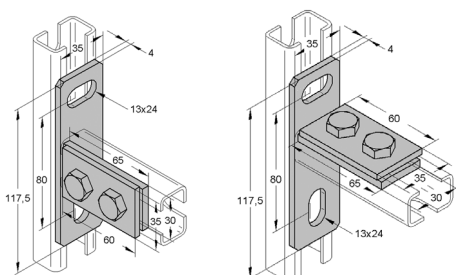

## Liitoskulma 35

malli	koodi	kp/ltk	€/kp/alv 0%
35/4 pysty	0816453	1	6,30

117,5x65x4 mm

35/4 vaaka	0816558	1	5,70
------------	---------	---	------

117,5x65x4 mm

Yhteensopivuus: 35 mm, 36 mm, Stex 35/20, 35/35